



# TRANSISTORIZED INVERTER

## INSTRUCTION MANUAL

### PARAMETER UNIT

# FR-PU04

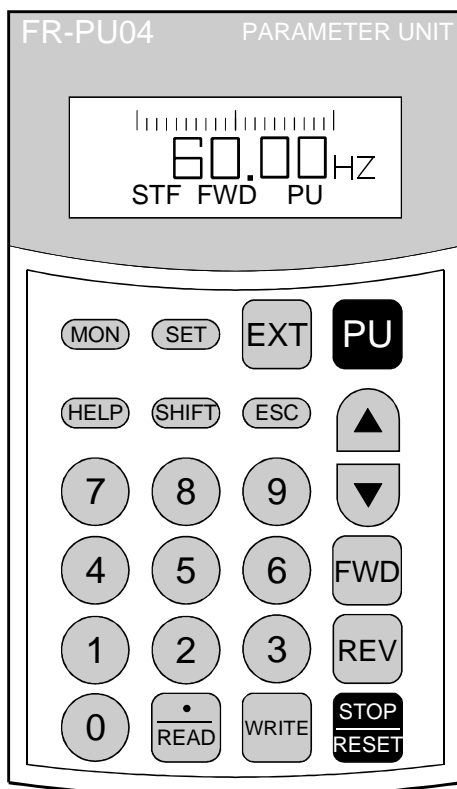

PRE-OPERATION INFORMATION **Chapter 1**

FUNCTIONS **Chapter 2**

HELP **Chapter 3**

OPERATION **Chapter 4**

SPECIFICATION **Chapter 5**

Thank you for choosing the Mitsubishi transistorized inverter option unit.

This instruction manual gives handling information and precautions for use of this equipment. Incorrect handling might cause an unexpected fault. Before using the equipment, please read this manual carefully to use the equipment to its optimum.

Please forward this manual to the end user.

This instruction manual uses the International System of Units (SI). The measuring units in the yard and pound system are indicated in parentheses as reference values.

## This section is specifically about safety matters.

Do not attempt to install, operate, maintain or inspect this product until you have read through this instruction manual and appended documents carefully and can use the equipment correctly. Do not use this product until you have a full knowledge of the equipment, safety information and instructions.

In this instruction manual, the safety instruction levels are classified into "WARNING" and "CAUTION".



Assumes that incorrect handling may cause hazardous conditions, resulting in death or severe injury.



Assumes that incorrect handling may cause hazardous conditions, resulting in medium or slight injury, or may cause physical damage only.

Note that the  level may lead to a serious consequence according to conditions. Please follow the instructions of both levels because they are important to personnel safety.

# SAFETY INSTRUCTIONS

## 1. Electric Shock Prevention

### **WARNING**

- Do not run the inverter with the front cover removed. Otherwise, you may access exposed high voltage terminals or charging devices and get an electric shock.
- Any person who is involved in the wiring or inspection of this equipment should be fully competent to do the work.
- Always install the inverter before wiring. Otherwise, you may get an electric shock or be injured.
- Operate the keys with dry hands to prevent an electric shock.

## 2. Additional Instructions

To prevent injury, damage or product failure, please note the following points.

### (1) Transportation and mounting

### **CAUTION**

- Do not install and operate the parameter unit (FR-PU04) if it is damaged or has parts missing.
- Do not stand or rest heavy objects on this equipment.
- Check the inverter mounting orientation is correct.
- The parameter unit (FR-PU04) is a precision device. Do not drop it or subject it to impact.
- Use the product under the following environmental conditions:

Environment	Conditions
Ambient temperature	-10°C to +50°C (non-freezing)
Ambient humidity	90%RH or less (non-condensing)
Storage temperature	-20°C to +65°C *
Ambience	Indoors (free from corrosive gas, flammable gas, oil mist, dust and dirt)
Altitude, vibration	Max. 1000m above sea level, 5.9m/s <sup>2</sup> or less (conforming to JIS C 0040)

\* Temperatures applicable for a short time, e.g. in transit.

## (2) Test operation and adjustment

### **CAUTION**

- Before starting operation, confirm and adjust the parameters. A failure to do so may cause some machines to make unexpected motions.

## (3) Usage

### **WARNING**

- The  key is only valid when function setting has been made. Provide an emergency stop switch separately.
- Make sure that the start signal is off before resetting the alarm. A failure to do so may restart the motor suddenly.
- Do not modify the equipment.

### **CAUTION**

- When parameter clear or all parameter clear is performed, each parameter returns to the factory setting. Re-set the required parameters before starting operation.

## (4) Corrective actions for alarm

### **CAUTION**

- Provide safety backup devices, such as an emergency brake, to protect machines and equipment from hazard if the parameter unit (FR-PU04) becomes faulty.

## (5) Disposal

### **CAUTION**

- Treat as industrial waste.

## (6) General instruction

All illustrations given in this manual may have been drawn with covers or safety guards removed to provide in-depth description. Before starting operation of the product, always return the covers and guards into original positions as specified and operate the equipment in accordance with the manual.

# - CONTENTS -

<b>1 PRE-OPERATION INFORMATION</b>	<b>1</b>
1.1 Overview .....	1
1.1.1 Appearance and parts identification .....	1
1.1.2 Explanation of the keys .....	1
1.2 Installation and Removal .....	3
1.2.1 Installation .....	3
(1) Installation to the inverter <b>A500</b> <b>F500</b> <b>E500</b> <b>-NA</b> <b>-EC</b> <b>-CH</b> <b>S500</b> <b>-NA</b> <b>-EC</b> <b>-CH</b> <b>F500J</b> <b>-CH</b> <b>C500</b> .....	3
(2) Using the connection cable (FR-CB2) for connection.....	3
1.2.2 Removal .....	4
(1) Removal from the inverter <b>A500</b> <b>F500</b> <b>E500</b> <b>-NA</b> <b>-EC</b> <b>-CH</b> <b>S500</b> <b>-NA</b> <b>-EC</b> <b>-CH</b> <b>F500J</b> <b>-CH</b> <b>C500</b> .....	4
(2) Removal when the connection cable (FR-CB2) is used .....	4
1.3 Parameters to Be Checked First .....	5
1.3.1 PU display language selection (Pr. 145) .....	5
1.3.2 PU buzzer control (Pr. 990).....	5
1.3.3 PU contrast adjustment (Pr. 991).....	5
<b>2 FUNCTIONS</b>	<b>6</b>
2.1 Monitoring Function.....	6
2.1.1 Display overview .....	6
(1) Main monitor .....	6
(2) PU level meter <b>A500</b> <b>F500</b> <b>E500</b> <b>-NA</b> <b>-EC</b> <b>-CH</b> <b>S500</b> <b>-NA</b> <b>-EC</b> <b>-CH</b> <b>F500J</b> <b>-CH</b> <b>C500</b> .....	6
(3) Rotation direction monitoring .....	6
(4) Operating status indication.....	6
(5) Operation mode indication .....	7
(6) Unit indication .....	7
(7) Alarm indication .....	7
2.1.2 Using the <b>(SHIFT)</b> key to change the main screen.....	8
2.1.3 Setting the first priority screen (first screen).....	8
2.1.4 Using the <b>(HELP)</b> key to change the main screen <b>A500</b> <b>F500</b> <b>E500</b> <b>-NA</b> <b>-EC</b> <b>-CH</b> <b>S500</b> <b>-NA</b> <b>-EC</b> <b>-CH</b> <b>F500J</b> <b>-CH</b> <b>C500</b> .....	9
2.1.5 Using the “PU main display data selection parameter” to change the screen.....	10



3.2.1 Monitor function.....	36
3.2.2 Selection of PU operation (direct input).....	38
3.2.3 Selection of the PU jog operation mode <b>A500</b> <b>F500</b> <b>E500</b> <b>-NA</b> <b>-EC</b> <b>-CH</b> <b>S500</b> <b>-NA</b> <b>-EC</b> <b>-CH</b> <b>F500J</b> <b>-CH</b> <b>C500</b> .....	39
(1) Calling from the help function menu.....	39
(2) Calling the key operation guide directly.....	39
3.2.4 Parameters.....	40
(1) "2 Pr. List".....	41
(2) Display of "3 Set Pr. List" <b>A500</b> <b>F500</b> <b>E500</b> <b>-NA</b> <b>-EC</b> <b>-CH</b> <b>S500</b> <b>-NA</b> <b>-EC</b> <b>-CH</b> <b>F500J</b> <b>-CH</b> <b>C500</b> .....	42
(3) Display of "4 Def. Pr. List" <b>A500</b> <b>F500</b> <b>E500</b> <b>-NA</b> <b>-EC</b> <b>-CH</b> <b>S500</b> <b>-NA</b> <b>-EC</b> <b>-CH</b> <b>F500J</b> <b>-CH</b> <b>C500</b> .....	42
(4) Display of "5 Def. Pr. List 2" <b>A500</b> <b>F500</b> <b>E500</b> <b>-NA</b> <b>-EC</b> <b>-CH</b> <b>S500</b> <b>-NA</b> <b>-EC</b> <b>-CH</b> <b>F500J</b> <b>-CH</b> <b>C500</b> .....	42
3.2.5 Parameter Clear.....	43
3.2.6 Alarm History.....	44
3.2.7 Alarm Clear.....	45
3.2.8 Inverter Reset.....	46
3.2.9 Troubleshooting <b>A500</b> <b>F500</b> <b>E500</b> <b>-NA</b> <b>-EC</b> <b>-CH</b> <b>S500</b> <b>-NA</b> <b>-EC</b> <b>-CH</b> <b>F500J</b> <b>-CH</b> <b>C500</b> .....	47
(1) Troubleshooting guidance.....	48
3.2.10 Selectop <b>A500</b> <b>F500</b> <b>E500</b> <b>-NA</b> <b>-EC</b> <b>-CH</b> <b>S500</b> <b>-NA</b> <b>-EC</b> <b>-CH</b> <b>F500J</b> <b>-CH</b> <b>C500</b> .....	51
3.2.11 Option.....	52
3.3 Other Precautions.....	53
3.3.1 Precautions for parameter unit operation.....	53
(1) Precautions for the digit count and decimal point of input value.....	53
(2) Other indications.....	53
(3) Power-on indication.....	53

<b>4 OPERATION</b>	<b>54</b>
--------------------	-----------

4.1 Operation Modes.....	54
4.1.1 How to select the operation mode.....	54
(1) Switching from external operation mode [EXT] to PU operation mode [PU].....	54
(2) Switching from PU operation mode [PU] to external operation mode [EXT].....	54
(3) Switching to the external / PU combined operation mode.....	54
4.2 PU Operation.....	56

4.2.1 Ordinary operation.....	56
4.2.2 PU jog operation <b>A500</b> <b>F500</b> <b>E500</b> -NA-EC-CH <b>S500</b> -NA-EC-CH <b>F500J</b> -CH C500.....	57
4.3 Combined Operation (Operation using external input signals and PU).....	58
4.3.1 Entering the start signal from outside and setting the running frequency from the PU (Pr. 79=3) .....	58
4.3.2 Entering the running frequency from outside and making start and stop from the PU (Pr. 79 = 4) .....	59
4.3.3 Entering the start signal and multi-speed signal from outside and setting multiple speeds from the PU .....	60

<b>5 SPECIFICATION</b>	<b>61</b>
------------------------	-----------

5.1 Specifications .....	61
5.1.1 Standard specifications .....	61
5.1.2 Outline drawing .....	62
5.1.3 Panel cutting drawing .....	62

# CHAPTER 1 PRE-OPERATION INFORMATION

This chapter provides the basic "pre-operation information (overview)" for use of this product.

Always read the instructions before using the equipment

1.1 Overview.....	1
1.2 Installation and Removal.....	3
1.3 Parameters to Be Checked First.....	5

The FR-PU04 can be used with the Mitsubishi transistorized inverters. However, there are restrictions on some functions depending on the model.

Note that the following representations are used in this manual.

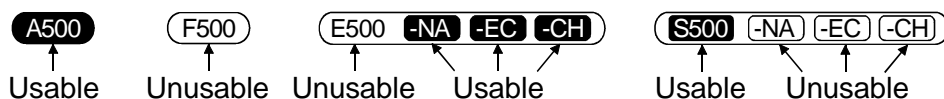

Chapter 1

Chapter 2

Chapter 3

Chapter 4

Chapter 5

# 1.1 Overview

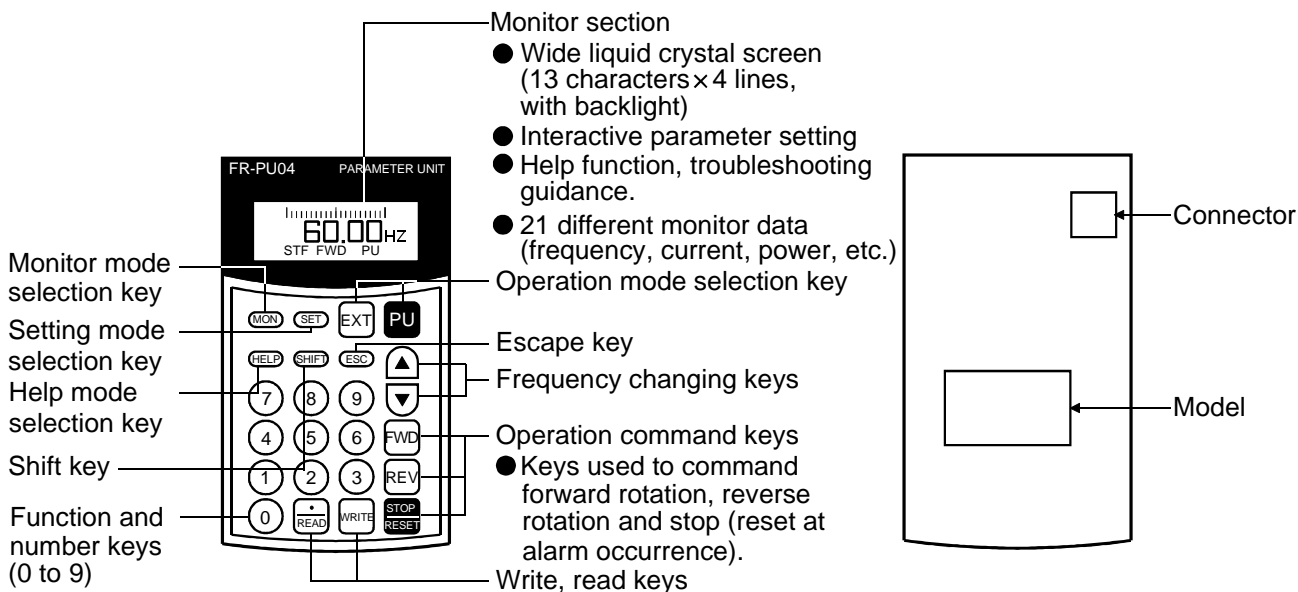

## 1.1.1 Appearance and parts identification

Unpack the parameter unit from the carton, check the name plate on the back, and make sure that the product has not been damaged before using the equipment.



## 1.1.2 Explanation of the keys

Key	Description
(SET) key	Used to select the parameter setting mode.
(MON) key	Used to display the main monitor.
(ESC) key	Operation cancel key.
(HELP) key	Used to select the help mode.
(SHIFT) key	Used to shift to the next item in the setting or monitoring mode.
Number keys ((0) to (9))	Used to enter a frequency, parameter number or set value.
(EXT) key	Used to select the external operation mode.
(PU) key	Used to select the PU operation mode.
(▲) and (▼) keys	Used to keep on increasing or decreasing the running frequency. Hold down to vary the frequency. Press either of these keys on the setting mode screen to change the parameter setting sequentially. On the monitoring, parameter or help menu screen, these keys are used to move the cursor. Hold down the (SHIFT) key and press either of these keys to advance or return the display screen one page. In the parameter copy or verify mode, the (▼) key is used as a verify key.
(FWD) key	Forward rotation command key.
(REV) key	Reverse rotation command key.
(STOP/RESET) key	<ul style="list-style-type: none"> <li>● Stop command key.</li> <li>● Used as a reset key when an alarm occurs.</li> </ul>

Key	Description
 key	<ul style="list-style-type: none"> <li>• Used to write a set value in the setting mode.</li> <li>• Used as a clear key in the all parameter clear or alarm history clear mode.</li> </ul>
 key	<p>Used also as a decimal point key.                      Used as a parameter number read key in the setting mode.                      Used as an item select key on the menu screen such as parameter list or monitoring list.                      Used as an alarm definition display key in the alarm history display mode.                      Used as a command voltage read key in the calibration mode.</p>
Display	13 character × 4 line liquid crystal display screen shows monitoring data, such as frequency, motor current and I/O terminal states, as well as troubleshooting guidance and other information.
Connector	Used for connection of the parameter unit with the inverter. You may either connect the unit directly or use the connection cable (FR-CB2□□) for connection.
Model	<div style="border: 1px solid black; padding: 5px; text-align: center;">                         FR-PU04    MITSUBISHI ELECTRIC CORPORATION                           MADE IN JAPAN                     </div>

**CAUTION**

1. Do not use a sharp-pointed tool to push the keys.
2. The display is a liquid crystal display. Do not press your fingers against the display.

## 1.2 Installation and Removal

### PRE-OPERATION INFORMATION

To ensure safety, install and remove the parameter unit after switching the power off.

### 1.2.1 Installation

#### (1) Installation to the inverter

**A500** **F500** **E500 -NA -EC -CH** **S500 -NA -EC -CH** **F500J -CH** **C500**

- 1) Remove the operation panel (FR-DU04) and accessory cover.
- 2) Insert the parameter unit straight and fit it securely.

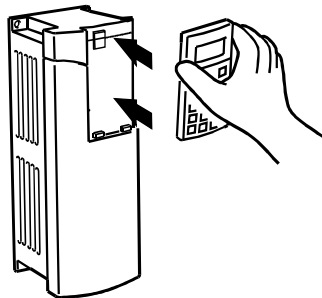

#### (2) Using the connection cable (FR-CB2) for connection

##### REMARKS

For details of the connection cable (FR-CB2), refer to the connection cable (FR-CB2) instruction manual.

##### ● When connecting to the FR-A500/ F500/ E500 series.

- 1) Remove the operation panel.
- 2) Insert the cable plugs securely into the connectors of the inverter and parameter unit (FR-PU04) along the cable guides until the stoppers are actuated.

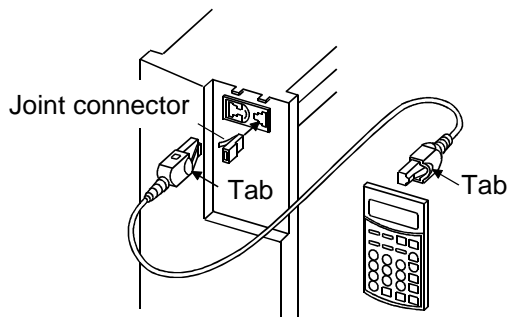

FR-A500 / F500 series.

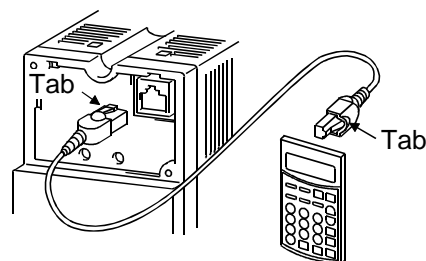

FR-E500 series.

##### CAUTION

Install the operation panel only when the front cover is installed.

● **When connecting to the FR-S500/ F500J/ C500 series.**

- 1) Remove the front cover.
- 2) Insert the cable plugs securely into the connectors of the inverter and parameter unit (FR-PU04) along the cable guides until the tabs snap into place.

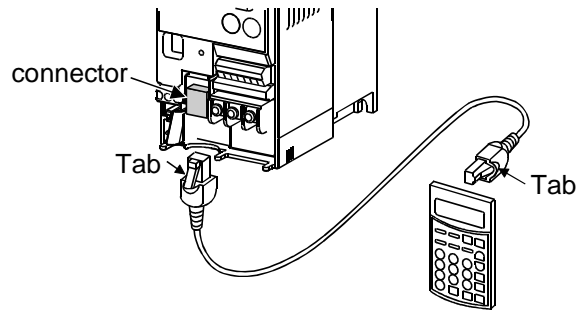

**REMARKS**

You can cut off the hook of the wiring cover to perform the wiring.  
 You can insert or pull the connector with the front cover installed.

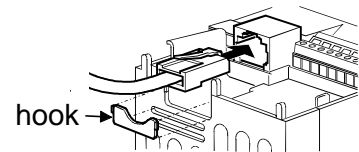

**1.2.2 Removal**

**(1) Removal from the inverter**

**A500** **F500** E500 (-NA) (-EC) (-CH) S500 (-NA) (-EC) (-CH) F500J (-CH) C500

Hold down the top button of the FR-PU04 and pull the parameter unit toward you, using the catches as a support.

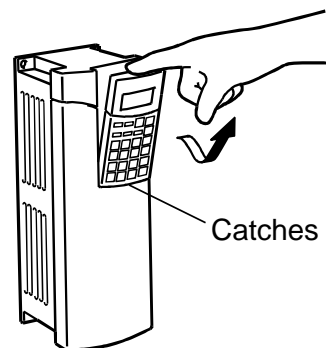

**(2) Removal when the connection cable (FR-CB2) is used**

Hold down the tab at the cable end and gently pull the plug.

# 1.3 Parameters to Be Checked First

Change the following parameter settings as required.  
For the changing procedures, refer to page 13.

## 1.3.1 PU display language selection (Pr. 145)

By setting the Pr. 145 "PU display language selection" value, you can select the language displayed on the parameter unit.

Pr. 145 Setting	Display Language
0	Japanese (factory setting of Japanese domestic version)
1	English (factory setting of NA version)
2	German
3	French
4	Spanish
5	Italian
6	Swedish
7	Finnish

## 1.3.2 PU buzzer control (Pr. 990)

By setting the Pr. 990 "PU buzzer control" value, you can select to either generate or mute the "beep" which sounds when you press any of the parameter unit keys.

Pr.990 Setting	Description
0	No sound
1	Sound generated (factory setting)

## 1.3.3 PU contrast adjustment (Pr. 991)

By setting the Pr. 991 "PU contrast adjustment" value, you can adjust the contrast of the parameter unit LCD.

Pr. 991 Setting	
0 to 63	

Note: If the  key is not pressed, the PU contrast setting is not stored.

Inverter	Pr. 991 factory setting
FR-A500	53
FR-F500	53
FR-E500	58

Inverter	Pr. 991 factory setting
FR-S500	58
FR-F500J	58
FR-C500	58

# CHAPTER 2

# FUNCTIONS

This chapter describes the "functions" for use of this product.

Always read the instructions before using the equipment.

2.1 Monitoring Function .....	6
2.2 Frequency Setting.....	11
2.3 Setting and Changing the Parameter Values.....	13
2.4 Calibration of the Meter (Frequency Meter) .....	19
2.5 Adjustment of the frequency setting signals	
"bias" and "gain" .....	23
2.6 Copy and Verify Functions.....	30

Chapter 1

Chapter 2

Chapter 3

Chapter 4

Chapter 5

# 2.1 Monitoring Function

## 2.1.1 Display overview

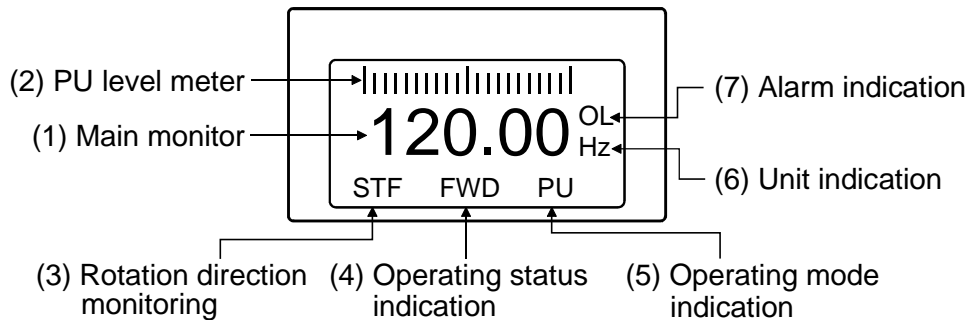

### (1) Main monitor

Shows the output frequency, output current, output voltage, alarm history and other monitor data.

- Using the **(SHIFT)** key to change to the next screen (refer to page 8)
- Using the **(HELP)** key to change to the next screen (refer to page 9)
- Using Pr. 52 "PU main display data selection" to change the main screen (refer to page 10)

### (2) PU level meter

**A500** **F500** **(E500 -NA -EC -CH)** **(S500 -NA -EC -CH)** **(F500J -CH)** **(C500)**

Setting the Pr. 53 "PU level display data selection" displays the data selected on the 5% graduated level meter.

Refer to the inverter instruction manual for details.

### (3) Rotation direction monitoring

Indicates the direction of rotation of the motor.

STF : Forward rotation

STR: Reverse rotation

- - - : No command or both STF and STR on

### (4) Operating status indication

Shows the operating status of the inverter.

STOP: During stop

FWD : During forward rotation

REV : During reverse rotation

JOGf : During job forward rotation

JOGr : During job reverse rotation

**(5) Operation mode indication**

Displays the status of the operation mode.

- EXT : External operation mode
- PU : PU operation mode
- EXTj : External jog mode
- PUj : PU jog mode
- NET : Link operation mode
- PU+E : External / PU combined operation mode
- PRG : Programmed operation mode

**(6) Unit indication**

Shows the unit of the main monitor.

**(7) Alarm indication**

Displays an inverter fault as an alarm.

---

**CAUTION**

---

This function varies with the inverter model.

---

- - - : Normal
- OL : Stall (current)
- oL : Stall (voltage)
- RB : Regenerative brake pre-alarm
- TH : Electronic overcurrent protection pre-alarm
- PS : PU stop

## 2.1.2 Using the (SHIFT) key to change the main screen

When "0" (factory setting) is set in Pr. 52 "PU main display data selection", merely pressing the (SHIFT) key calls 6 different monitor screens in sequence.

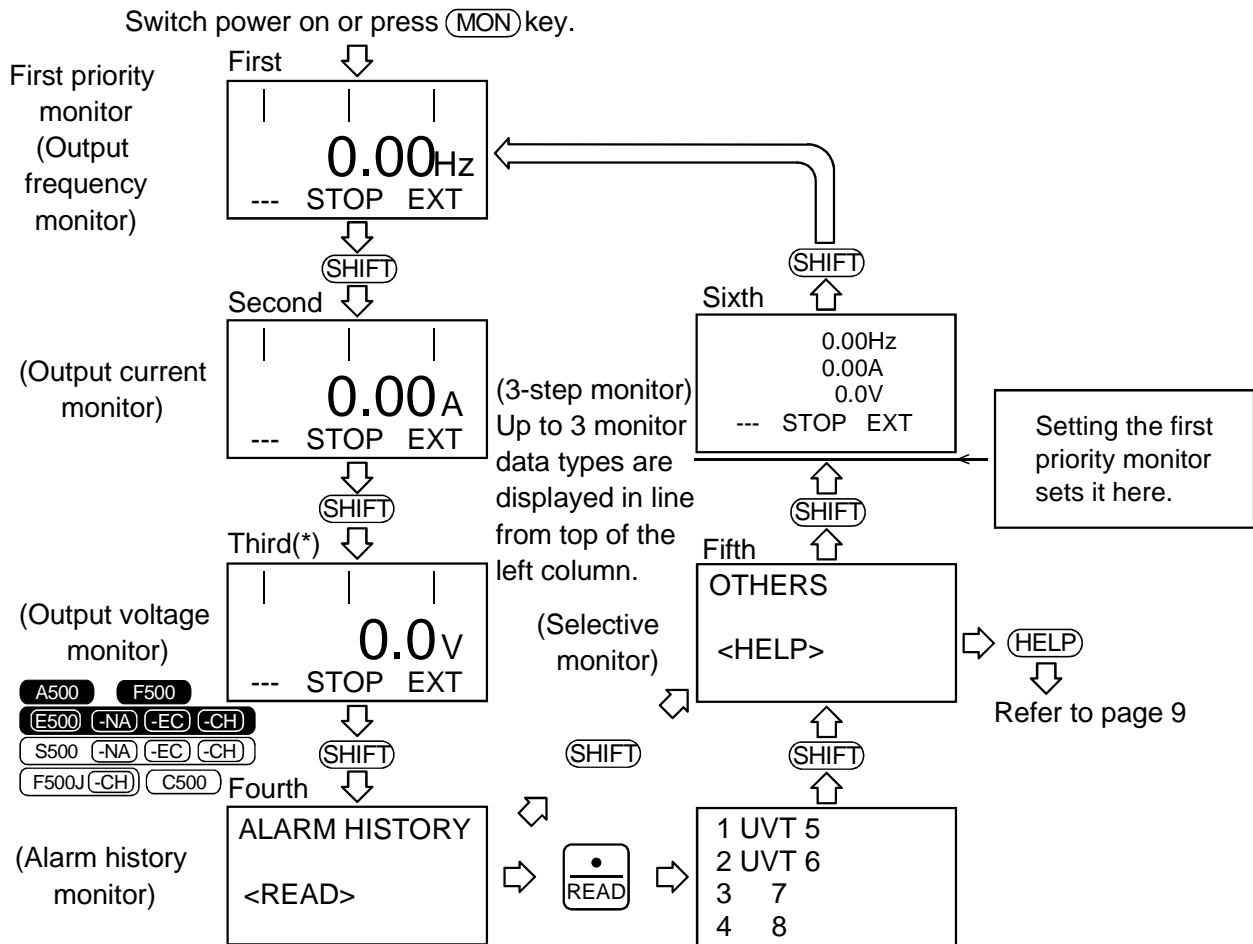

\*For the FR-S500 series, the third monitor is also output current monitor.

## 2.1.3 Setting the first priority screen (first screen)

Set the screen which appears first when power is switched on or the (MON) key is pressed.

- When you press the (WRITE) key with any screen other than ALARM HISTORY and OTHERS being displayed, that screen is set as the first priority screen and will be displayed first.
- You cannot set "15 I/P Signal", "16 O/P Signal" or multiple simultaneous screens as the first priority screen.

### 2.1.4 Using the **HELP** key to change the main screen

**A500** **F500** **E500 (-NA) (-EC) (-CH)** **S500 (-NA) (-EC) (-CH)** **F500J (-CH)** **C500**

#### CAUTION

The functions vary with the inverter model. (Refer to page 32 for details of the help functions.)

#### ● Example: Select the output current peak value monitor.

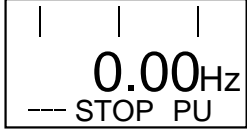
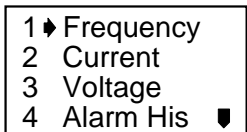
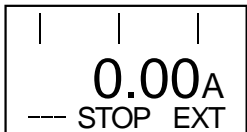
<p>1) Press the <b>MON</b> key. The parameter unit is placed in the monitoring mode.</p>	
<p>2) Press the <b>HELP</b> key. The monitoring list appears.</p>	
<p>3) Hold down the <b>SHIFT</b> key and press the <b>▼</b> key twice, then release the <b>SHIFT</b> key, and press the <b>▼</b> key twice. (Moves the cursor to Peak I.)</p>	<p>..... Hold down <b>SHIFT</b> and press the <b>▼</b> or <b>▲</b> key to shift the screen one page.</p>
<p>4) Press the <b>READ</b> key. The screen shown on the right appears.(*1)</p>	
<p>5) Press the <b>WRITE</b> key. The screen in step 4) is set as the first priority screen. (*2)</p>	<p>..... Subsequently press the <b>SHIFT</b> key to call another monitor screen.</p>

2

- \*1. The selective monitor screen is not yet the first priority screen in the above step 4) when the **READ** key was pressed. Hence, the selected item is erased from memory as soon as the power is switched off or another operation mode (such as external operation) is selected.  
In this case, the item must be selected again in the above procedure. When you press the **WRITE** key to select the first priority screen, the selected item is stored in memory.
- \*2. In step 5) where the **WRITE** key was pressed in the above setting example, the "output current peak" selected here is first displayed with priority when the other operation mode is switched to the monitoring mode. To give first priority to another monitor screen, press the **WRITE** key with that monitor screen being displayed. (Refer to page 8.)

#### REMARKS

Refer to page 32 for details of the help functions.

● When "current monitor" or "power monitor" is selected

Note that any current or power not more than 5% of the rated inverter current cannot be detected and displayed.

Example: When a small motor is used with a large-capacity inverter (a 0.4kW motor is used with a 55kW inverter), power monitor is inoperative.

2.1.5 Using the "PU main display data selection parameter" to change the screen

By setting the Pr. 52 value, you can change the "second" and "third" screen displays from the first priority screen using the (SHIFT) key.

**CAUTION**

The functions vary with the inverter model. (Refer to the inverter instruction manual for details of the "PU main display data selection parameter".)

Inverter	Pr. 52 Setting	
	Setting values displayed in place of output current monitor	Setting values displayed in place of output voltage monitor
FR-A500 series	17 (load meter) 18 (motor excitation current) 24 (motor load factor)	19 (position pulse) 20 (cumulative energization time) 22 (orientation status) 23 (actual operation time) 25 (cumulative power)
FR-F500 series	17 (load meter) 24 (motor load factor)	20 (cumulative energization time) 23 (actual operation time) 25 (cumulative power)
FR-E500 series	-	23 (actual operation time)
FR-S500/F500J/ C500 series	-	-

**Factory setting**

\* The monitor displayed at powering on is the first priority monitor. Refer to page 8 for the setting method of the first priority monitor.

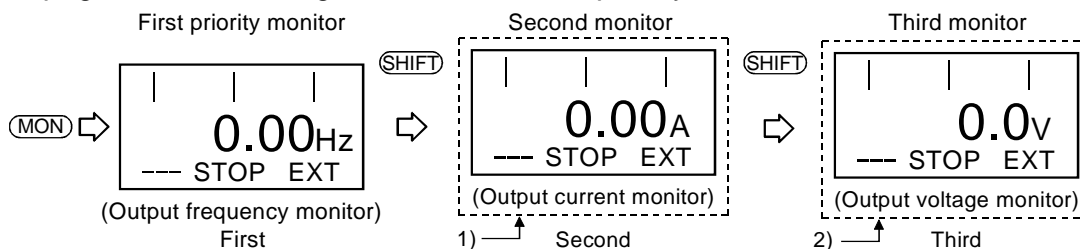

1) For the set value of "17, 18, 24", their monitors are displayed at the second monitor instead of output current monitor.

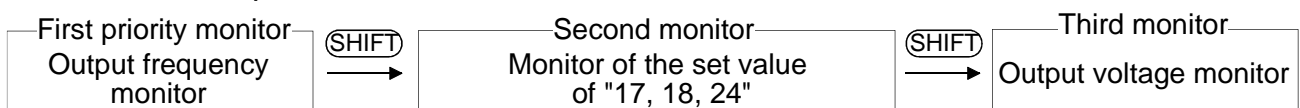

2) For the set value of "19 to 23, 25", their monitors are displayed at the third monitor instead of output voltage monitor.

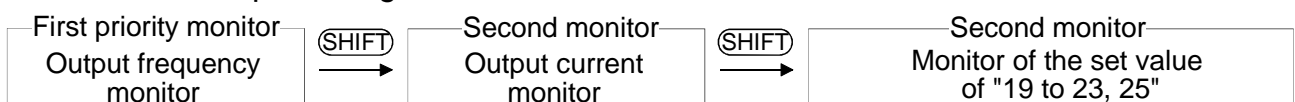

## 2.2 Frequency Setting

Make this setting in the PU operation mode.

### REMARKS

The external start signal (STF or STR) must not be ON to switch from external operation mode to PU operation mode.

### 2.2.1 Direct setting

#### ● Operation procedure (Changing from 0Hz setting to 60Hz setting)

1) Press the <b>PU</b> key. ....The frequency setting screen appears.	
2) Press the <b>6</b> and <b>0</b> keys. (Remarks)	
3) Press the <b>WRITE</b> key. ....Register the 60Hz setting. (Setting complete)	

### REMARKS

If you entered an incorrect value, press the **ESC** key to return to the pre-entry state.

### 2.2.2 Step setting

1) Press the <b>PU</b> key. ....The frequency setting screen appears.	
2) Press the <b>▲/▼</b> key to enter any value (60.00Hz). (Remarks 1) You can set any value between the maximum frequency (Pr. 1) and minimum frequency (Pr. 2).	
3) Press the <b>WRITE</b> key. ....Register the 60Hz setting. (Setting complete)	

### REMARKS

1. If you entered an incorrect value, press the **ESC** key to return to the pre-entry state.
2. During operation, you can also make the step setting to change the running frequency. If you operate the **▲/▼** key in the monitor mode, however, the frequency will not stop when you release the key but will further increase (or decrease). (Since the **▲/▼** key is used to vary the preset frequency, the varied frequency will differ from the output frequency.)

### 2.2.3 Precautions for frequency setting

- 1) Pr. 79 "operation mode selection" must have been set to make the "PU operation mode" valid.
- 2) In the monitor mode, you cannot make the setting directly (refer to page 11) to set the running frequency. Perform the step setting (refer to page 11) and press the **WRITE** key, or press the **PU** key to deselect the monitor mode before starting frequency setting.

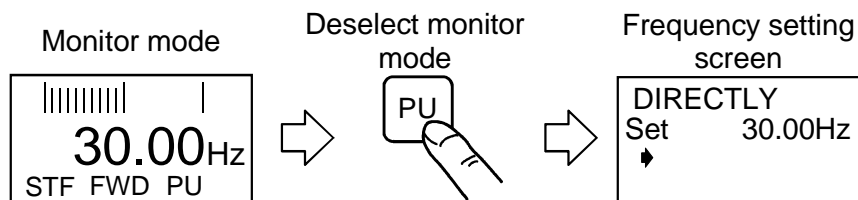

## 2.3 Setting and Changing the Parameter Values

The inverter has a number of parameters. Using the PU, you can choose parameters required for operation and set and/or change their values as appropriate according to the load and running conditions. Set "1" in Pr. 77 "parameter write inhibit selection" to inhibit write.

### CAUTION

The functions vary with the inverter. (Refer to the inverter instruction manual for details of the parameters.)

### 2.3.1 Direct setting

#### ● Operation procedure (Example: Reading and writing the Pr. 8 "deceleration time" value)

1) Press the <b>PU</b> key. The frequency setting screen appears.	DIRECTLY Set 0.00Hz ▶
2) Press the <b>SET</b> key. The parameter unit enters the parameter setting mode.	SETTING MODE Set Pr. NO. FOR PR. List <HELP>
3) Press the required parameter number <b>8</b> . The screen on the right appears.	SETTING MODE Pr. NO. 8 <READ>
4) Press the <b>READ</b> key. The current setting appears on the display.	8 Dec. T1 5.0S ▶
5) Enter the required value ( <b>1 8 0</b> ). (Example: To set to 180s) A new setting appears on the display.(*)	8 Dec. T1 5.0S ▶ 180S
6) Press the <b>WRITE</b> key. The setting is stored into memory. If an error is displayed when you press the <b>WRITE</b> key, refer to page 47.	8 Dec. T1 <b>180.0S</b> Completed
7) Press the <b>SHIFT</b> key to move to the next parameter (Pr. 9) and call the current setting. Then, press the <b>SHIFT</b> key to advance to the next parameter.	9 Set THM 2.55A ▶

### REMARKS



\*If you entered an incorrect value, press the **ESC** key to return to the pre-entry state.

**POINT**











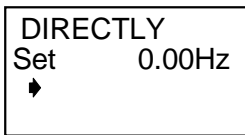

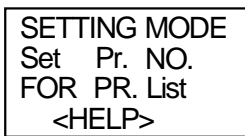

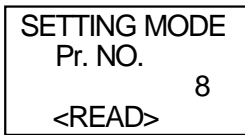
Set and/or change the parameter values in the PU operation mode. When the PU operation indication is not shown, refer to page 54 and switch to the PU operation mode. Note that the values of some parameters may be set and/or changed in the external operation and combined operation modes. For the parameters whose values can be set and changed, refer to the inverter instruction manual.

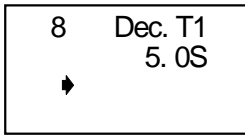
In addition to the above procedure, the help function may be used to call the parameter list for setting. For more information, refer to page 32.

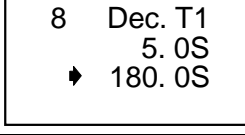
### 2.3.2 Step setting

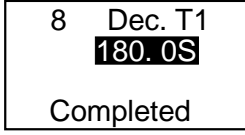
The way to vary the frequency continuously using the  key is shown below. You can vary the frequency while you press the  key. Since the frequency varies slowly at first, this setting can be used for fine adjustment.

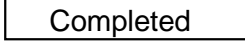
#### ● Operation procedure (Example: Reading and writing the Pr. 8 "deceleration time" value)

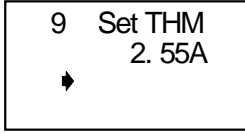
1) Press the  key.	.....The frequency setting screen appears.	
2) Press the  key.	.....The parameter unit enters the parameter setting mode.	
3) Press the required parameter number  .	.....The screen on the right appears.	
4) Press the  key.	.....The current setting appears on the display.	
5) Press the  key until the required value appears. (*)	.....A new setting appears on the display. (Note 1)	
6) Press the  key.	.....The setting is stored into memory.	
If an error is displayed when you press the  key, refer to page 48.		
7) Press the  key to move to the next parameter (Pr. 9) and call the current setting. Then, press the  key to advance to the next parameter.		

**REMARKS**

\*If you entered an incorrect value, press the  key to return to the pre-entry state.

### 2.3.3 Function-by-function parameter setting

**A500** **F500** E500 (-NA) (-EC) (-CH) S500 (-NA) (-EC) (-CH) F500J (-CH) C500

You can set and/or change only the parameters classified function-by-function.

<p>1) Press <b>SET</b> key. The parameter unit is put in the setting mode.</p>	<div style="border: 1px solid black; padding: 5px;">             SETTING MODE              Set Pr. NO              Pr. List →HELP              Pr. COPY →  </div>								
<p>2) Press <b>READ</b> key. Select "2 " with the  key and press the <b>READ</b> key to read.</p>	<div style="border: 1px solid black; padding: 5px;">             &lt;List select&gt;              ♦ 1 User List              2 Appl. Grp         </div>								
<p>3) Selecting the function Select the function with the  key and press the <b>READ</b> key to read.</p>	<div style="border: 1px solid black; padding: 5px;">             ♦ 1 Shaft Trp              2 F Command              3 Acc. Dec.              4 Shut Off         </div>								
<p>4) Parameter read Select the parameter to be set with the  key and press the <b>READ</b> key to read the parameter setting screen.</p>	<div style="border: 1px solid black; padding: 5px;"> <table style="width: 100%; border-collapse: collapse;"> <tr> <td style="width: 50%;">Pr. NO.</td> <td style="width: 50%;">Pr. NAME</td> </tr> <tr> <td>Pr. NO.</td> <td>Pr. NAME</td> </tr> <tr> <td>Pr. NO.</td> <td>Pr. NAME</td> </tr> <tr> <td>Pr. NO.</td> <td>Pr. NAME</td> </tr> </table> </div>	Pr. NO.	Pr. NAME	Pr. NO.	Pr. NAME	Pr. NO.	Pr. NAME	Pr. NO.	Pr. NAME
Pr. NO.	Pr. NAME								
Pr. NO.	Pr. NAME								
Pr. NO.	Pr. NAME								
Pr. NO.	Pr. NAME								
<p>5) Parameter setting Type the set value with the number keys and press the <b>WRITE</b> key to enter.</p>	<div style="border: 1px solid black; padding: 5px;"> <table style="width: 100%; border-collapse: collapse;"> <tr> <td style="width: 50%;">Pr. NO</td> <td style="width: 50%;">Pr. NAME</td> </tr> <tr> <td colspan="2" style="text-align: center;">♦</td> </tr> </table> </div>	Pr. NO	Pr. NAME	♦					
Pr. NO	Pr. NAME								
♦									

### 2.3.4 User parameter registration and deletion

**A500** **F500** **E500** **-NA** **-EC** **-CH** **S500** **-NA** **-EC** **-CH** **F500J** **-CH** **C500**

Among all parameters, a total of 32 parameters can be registered to two different user groups.

The registered parameters may only be accessed in the same procedure as in Pr. 160 "user group read selection".

#### **(1) Confirmation**

Confirm the user-registered parameters.

<p>1) Press <b>SET</b> key. The parameter unit is put in the parameter setting mode.</p>	<div style="border: 1px solid black; padding: 5px;"> <p>SETTING MODE Set Pr. NO Pr. List →HELP Pr. COPY → </p> </div>
<p>2) Press <b>READ</b> key. The parameter classification monitor screen appears. Select "1 " with the  key and press the <b>READ</b> key to advance to the next monitor screen.</p>	<div style="border: 1px solid black; padding: 5px;"> <p>&lt;List select&gt; ▶ 1 User List 2 Appl. Grp</p> </div>
<p>3) User group selection Select the user group with the  key and press the <b>READ</b> key to read the parameters.</p>	<div style="border: 1px solid black; padding: 5px;"> <p>▶ 1 User List1 2 User List2</p> </div>
<p>4) You can confirm the parameters registered to the user group.</p>	<div style="border: 1px solid black; padding: 5px;"> <p>Pr. NO. Pr. NAME Pr. NO. Pr. NAME Pr. NO. Pr. NAME Pr. NO. Pr. NAME</p> </div>

#### **REMARKS**

If the read parameter is not the user-set parameter, "Setting Err." will be displayed.  
Press the **ESC** key to return to "User group selection" in above 3).

**(2) Registration**

<p>1) Press <b>(SET)</b> key. The parameter unit is put in the parameter setting mode.</p>	<pre>SETTING MODE Set Pr. NO Pr. List  →HELP Pr. COPY →  ▬</pre>
<p>2) Enter the parameter number to be registered to the user group with the number keys, and press the <b>(READ)</b> key to read the parameter setting.</p>	<pre>SETTING MODE Pr. NO.  ▬▬▬▬ &lt;READ&gt;</pre>
<p>3) When changing the parameter setting, enter a new value with the number keys and press the <b>(WRITE)</b> key to write.</p>	<pre>Pr. NO. Pr. NAME ▬▬▬▬ ▬▬▬▬ ▬</pre>
<p>4) Press <b>(WRITE)</b> key. Select the user registration destination with the <b>(▲)</b>/<b>(▼)</b> key and press the <b>(READ)</b> key to read.</p>	<pre>&lt;Add Pr. List&gt; 1 User List1 2 User List2 3 Def Pr.</pre>
<p>5) Select Yes: or No: with the <b>(▲)</b>/<b>(▼)</b> key and press the <b>(WRITE)</b> key to enter.</p>	<pre>Add Pr. User List1 ▬ Yes : Add No : Cancel</pre>

**REMARKS**

If the read parameter is not the user-set parameter, "Setting Err." will be displayed.  
Press the **(ESC)** key to return to "parameter read" in above 2).

### (3) Deletion

<p>1) Press <b>(SET)</b> key. The parameter unit is put in the setting mode.</p>	<div style="border: 1px solid black; padding: 5px;">             SETTING MODE              Set Pr. NO              Pr. List →HELP              Pr. COPY →  </div>
<p>2) Press <b>(READ)</b> key. Select "1 " with the  key and press the <b>(READ)</b> key to read.</p>	<div style="border: 1px solid black; padding: 5px;">             &lt;List select&gt;              ♦ 1 User List1              2 Appl. Grp         </div>
<p>3) Select the user group with the  key and press the <b>(READ)</b> key to read the parameters.</p>	<div style="border: 1px solid black; padding: 5px;">             ♦ 1 User List1              2 User List2         </div>
<p>4) Select the parameter to be deleted with the  key and press the <b>(WRITE)</b> key to enter.</p>	<div style="border: 1px solid black; padding: 5px;">             Pr. NO. Pr. NAME              Pr. NO. Pr. NAME              Pr. NO. Pr. NAME              Pr. NO. Pr. NAME         </div>
<p>5) Select Yes: or No: with the  key and press the <b>(WRITE)</b> key to enter.</p>	<div style="border: 1px solid black; padding: 5px;">             Delet Pr.              User List              ♦ Yes : Delete              No : Cancel         </div>

### 2.3.5 Precautions for setting write

- Perform write when the inverter is at a stop in the PU operation mode or combined operation mode. Write cannot be performed in the external operation mode. (Read may be performed in any operation mode.) However, some parameters can be accessed for write in the external operation mode or during operation. Refer to the instruction manual of the inverter used.
- In addition to the above case, setting write cannot be performed when:
  - 1) Parameter write disable (Pr. 77) has been set;
  - 2) The parameter number selected does not exist in the parameter list; or
  - 3) The value entered is outside the setting range.
- When write cannot be performed and an error (×) appears, press the **(ESC)** key and make setting once more.

(Example: For Pr. 7 "Acceleration time")

7 Acc. T1  
 Setting Error  
 ✖ 20000S  
 <ESC>

## 2.4 Calibration of the Meter (Frequency Meter)

### CAUTION

The functions vary with the inverter. (Refer to the inverter instruction manual for details of the parameters.)

### 2.4.1 Calibration of the FM terminal

**A500** **F500** **E500** (-NA) (-EC) (-CH) **S500** (-NA) (-EC) (-CH) **F500J** (-CH) **C500**

- This section provides the way to calibrate the meter connected to terminal FM to full-scale using the parameter unit.
- Calibrating the meter at the running frequency of 60Hz

#### Parameter

Pr. 900	"FM terminal calibration"
Pr. 54	"FM terminal function selection"
Pr. 55	"frequency monitoring reference"

1) Press the <b>SET</b> key in the PU operation mode. The parameter unit is placed in the parameter setting mode.	SETTING MODE Set Pr. NO. FOR PR. List <HELP>
2) Type <b>9</b> <b>0</b> <b>0</b> with the number keys and press the <b>READ</b> key. The preset frequency is displayed.	900 FM Tune RUN Inverter Set 0.00Hz PU
3) Type <b>6</b> <b>0</b> with the number keys and press the <b>WRITE</b> key. The screen changes as shown on the right.	900 FM Tune RUN Inverter Set 60Hz PU
4) Press the <b>FWD</b> key to start forward rotation at 60Hz. You need not connect the motor.	900 FM Tune MntrF 60.00Hz ▶▶▶<WRITE>PU
5) Using the <b>▲</b> / <b>▼</b> key, adjust the meter pointer to a predetermined position. The meter pointer moves. (It takes a long time before the pointer moves.)	
6) Press the <b>WRITE</b> key. Calibration is complete.	900 FM Tune Completed <MONITOR>

Press the **MON** key to return to the main monitor screen.

### 2.4.2 Calibration of the AM terminal

**A500** **F500** **E500** **-NA** **-EC** **-CH** **S500** **-NA** **-EC** **-CH** **F500J** **-CH** **C500**

- This section provides a way to calibrate the meter connected to terminal AM using the parameter unit.
- Calibration procedure 1 (Example: To calibrate the meter at the running frequency of 60Hz)

**Parameter**

Pr. 901	"AM terminal calibration"
Pr. 158	"AM terminal function selection"
Pr. 55	"frequency monitoring reference"
Pr. 56	"current monitoring reference"

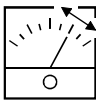
1) Press the <b>(SET)</b> key in the PU operation mode. The parameter unit enters the parameter setting mode.	SETTING MODE Set Pr. NO. FOR PR. List <HELP>
2) Type <b>(9)</b> <b>(0)</b> <b>(1)</b> with the number keys and press the <b>(READ)</b> key. The current PU-set frequency appears.	901 AM Tune RUN Inverter Set ▶ 0.00Hz PU
3) Type <b>(6)</b> <b>(0)</b> with the number keys and press the <b>(WRITE)</b> key. The screen changes as shown on the right.	901 AM Tune RUN Inverter Set 60.00Hz PU
4) Press the <b>(FWD)</b> key to start forward rotation at 60Hz. You need not connect the motor.	901 AM Tune MntrF 60.00Hz ▶▶▶<WRITE>PU
5) Using the <b>(▲)</b> / <b>(▼)</b> key, adjust the meter pointer to a predetermined position. The meter pointer moves. (It will take a long time until the pointer moves.)	
6) Press the <b>(WRITE)</b> key. Calibration is complete.	901 AM Tune Completed <MONITOR>

Press the **(MON)** key to return to the main monitor screen.

● Calibration procedure 2 (Example: Output current)

To output the output current or another item which cannot easily achieve a 100% value if operation is performed, adjust the reference voltage output (when the Pr. 158 "AM terminal function selection" setting is "21"), then select any of the choices displayed.

Setting of reference voltage output

<p>1) Press the <b>SET</b> key in the PU operation mode. The parameter unit is placed in the parameter setting mode.</p>	<pre>SETTING MODE Set Pr. NO. FOR PR. List &lt;HELP&gt;</pre>
<p>2) Type <b>1 5 8</b> with the number keys and press the <b>READ</b> key. The current Pr. 158 setting appears.</p>	<pre>158 Set AM   1   ◆</pre>
<p>3) Type <b>2 1</b> with the number keys and press the <b>WRITE</b> key. The setting of reference voltage output is complete.</p>	<pre>158 Set AM   1   ◆ 21 Completed</pre>
<p>4) Press the <b>SET</b> key. The parameter unit is put in the parameter setting mode.</p>	<pre>SETTING MODE Set Pr. NO. FOR PR. List &lt;HELP&gt;</pre>
<p>5) Type <b>9 0 1</b> with the number keys and press the <b>READ</b> key. The current Pr. 901 setting appears.</p>	<pre>901 AM Tune RUN Inverter Set ◆ 0.00Hz   PU</pre>
<p>6) Type <b>6 0</b> with the number keys and press the <b>WRITE</b> key. The setting of maximum running frequency is complete.</p>	<pre>901 AM Tune RUN Inverter Set 60.00Hz   PU</pre>
<p>7) Press the <b>FWD</b> key. Forward rotation is performed at 60Hz. You need not connect the motor to make adjustment.</p>	
<p>8) Using the <b>▲</b> or <b>▼</b> key, adjust the voltage across terminals AM-5 and press the <b>WRITE</b> key. Setting is complete.</p>	<pre>901 AM Tune Completed &lt;MONITOR&gt;</pre>

..... The output voltage displayed is the value at 100% output. This voltage is not stored if you do not press the **WRITE** key.

Setting of output current

<p>9) Press the <b>SET</b> key. The parameter unit is put in the parameter setting mode.</p>	<pre>SETTING MODE Set Pr. NO. FOR PR. List &lt;HELP&gt;</pre>
<p>10) Type <b>1 5 8</b> with the number keys and press the <b>READ</b> key. The current Pr. 158 setting appears.</p>	<pre>158 Set AM       1   ▶</pre>
<p>11) Type <b>2</b> with the number keys and press the <b>WRITE</b> key. The setting of output current is complete.</p>	<pre>158 Set AM       1       21   ▶ Completed</pre>

..... The current set in Pr. 56 "current monitoring reference" is at 100% value and the output at this point is the voltage.

## 2.5 Adjustment of the frequency setting signals "bias" and "gain"

### FUNCTIONS

The functions vary with the inverter model. (Refer to the inverter instruction manual for details of the functions.)

### 2.5.1 Adjustment procedure

**A500** **F500** ~~E500-NA~~ ~~EC-CH~~ ~~S500-NA~~ ~~EC-CH~~ ~~F500J-CH~~ C500

There are three ways to adjust the bias and gain of the frequency setting voltage (current).

- 1) Adjust only the bias and gain frequencies and not adjust the voltage (current)
- 2) Adjust any point by applying a voltage across terminals 2-5 (starting a current across terminals 4-5)
- 3) Adjust any point without a voltage being applied across terminals 2-5 (without a current being started across terminals 4-5)

#### Parameter

Pr. 902	"frequency setting voltage bias"
Pr. 903	"frequency setting voltage gain"
Pr. 904	"frequency setting current bias"
Pr. 905	"frequency setting current gain"

**(1) Adjust only the bias and gain frequencies and not adjust the voltage**

● Setting of the frequency setting voltage bias

<p>1) Press the <b>PU</b> key. The frequency setting screen appears.</p>	<p>DIRECTLY Set 0.00Hz ↓</p>
<p>2) Press the <b>SET</b> key. The parameter unit is put in the parameter setting mode.</p>	<p>SETTING MODE Set Pr. NO. FOR PR. List &lt;HELP&gt;</p>
<p>3) Type <b>9 0 2</b> with the number keys.</p>	<p>SETTING MODE Pr. NO. 902 &lt;READ&gt;</p>
<p>4) Press the <b>READ</b> key. The current Pr. 902 setting appears.</p>	<p>902 EXTvbias ↓ 0.00Hz Set ↓ &lt;WRITE&gt; EXT ↓ &lt;READ&gt;</p>
<p>5) Type <b>1 0</b> with the number keys.</p>	<p>902 EXTvbias ↓ 10.00Hz Set ↓ &lt;WRITE&gt; EXT ↓ &lt;READ&gt;</p>
<p>6) Press the <b>WRITE</b> key. The set value is stored into memory and bias setting is complete.</p>	<p>902 EXTvbias 10.00 Hz Completed</p>

..... Voltage need not be applied across terminals 2-5.

..... The bias setting is 10Hz.

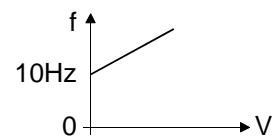

If the voltage is being applied across terminals 2-5 at this time, the bias setting is as shown above.

● Setting of the frequency setting voltage gain

<p>7) Press the <b>SHIFT</b> key. The current Pr. 903 setting appears.</p>	<pre>903 EXTVgain   ▶ 60.00Hz Set ▶ &lt;WRITE&gt; EXT ▶ &lt;READ&gt;</pre>
<p>8) Type <b>5</b> <b>0</b> with the number keys.</p>	<pre>903 EXTVgain   ▶ 50.00Hz Set ▶ &lt;WRITE&gt; EXT ▶ &lt;READ&gt;</pre>
<p>9) Press the <b>WRITE</b> key. The set value is stored into memory and gain setting is complete.</p>	<pre>903 EXTVgain   ▶ 50.00 Hz Completed</pre>

..... Voltage need not be applied across terminals 2-5. At this time, set the gain on the assumption that the 5V (10V) in the inverter is the set voltage.

The adjustment of the frequency setting voltage bias and gain is complete.

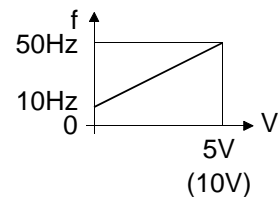

**REMARKS**

1. The current input (Pr. 904, Pr. 905) can also be adjusted using a similar procedure.
2. The Pr. 903 (frequency setting gain) value remains unchanged if the Pr. 20 "acceleration/deceleration reference frequency" setting is changed.
3. A narrow calibration (command) value set using Pr. 902 and Pr. 903 (Pr. 904 and Pr. 905) will result in "Setting Error" and disable write.

**(2) Any point is adjusted with a voltage applied across terminals 2-5**

● Setting of the frequency setting voltage bias

<p>1) Press the <b>PU</b> key. The frequency setting screen appears.</p>	<pre>DIRECTLY Set    0.00Hz   ↓ 0~400</pre>
<p>2) Press the <b>SET</b> key. The parameter unit is put in the parameter setting mode.</p>	<pre>SETTING MODE Set Pr. NO. FOR PR. List &lt;HELP&gt;</pre>
<p>3) Type <b>9 0 2</b> with the number keys.</p>	<pre>SETTING MODE Pr. NO.           902 &lt;READ&gt;</pre>
<p>4) Press the <b>READ</b> key twice. The current Pr. 902 setting appears.</p>	<pre>902 EXTVbias   ↓    5.00Hz     -   0.5% EXT   20.0%</pre>
<p>5) Type <b>1 0</b> with the number keys.</p>	<pre>902 EXTVbias   ↓    10.00Hz     -   0.5% EXT -  20.0%</pre>
<p>6) Press the <b>WRITE</b> key. The cursor (▶) moves to the set voltage.</p>	<pre>902 EXTVbias   ↓    10.00Hz     ▶ -   0.5% EXT   20.0%</pre>
<p>7) Apply a 0V voltage.</p>	<pre>902 EXTVbias   ↓    10.00Hz     ▶ -   0.5% EXT -  0.2%</pre>
<p>8) Press the <b>WRITE</b> key. The set value is stored into memory and bias setting is complete.</p>	<pre>902 EXTVbias   ↓    10.00Hz     -   0.2% Completed</pre>

The previous setting is displayed.  
The current set voltage across terminals 2-5 is displayed in %.  
When the set voltage is changed, the % value also changes.  
(This example assumes that a 1V voltage is applied.  
The value selected in Pr. 73 (5V in this example) is 100%.  
..... Adjust the set voltage.  
If the voltage set is 1V, the bias setting is as shown below:

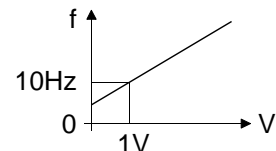

..... In this example, 0V is applied as 10Hz is set for 0V.  
(Indicated on the right of changes.)  
0.0% may not be displayed in some cases.  
Setting is completed as shown below:

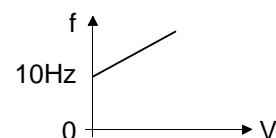

(Continued on the next page)

(From the preceding page)

● Setting of the frequency setting voltage gain

<p>9) Press the <b>SHIFT</b> key, then the <b>READ</b> key. The current Pr. 903 setting appears.</p>	<div style="border: 1px solid black; padding: 5px;"> <p>903 EXT Vgain              ▶ 60.00Hz              97.1%              EXT 99.0%</p> </div>	<p>The previous setting is displayed. The current set voltage across terminals 2-5 is displayed in %.</p>
<p>10) Type <b>5</b> <b>0</b> with the number keys.</p>	<div style="border: 1px solid black; padding: 5px;"> <p>903 EXT Vgain              ▶ 50.00Hz              97.1%              EXT 99.0%</p> </div>	<p>When the set voltage is changed, the % value also changes. (The value selected in Pr. 73 (5V in this example) is 100%.)</p>
<p>11) Press the <b>WRITE</b> key. The cursor (▶) moves to the set voltage.</p>	<div style="border: 1px solid black; padding: 5px;"> <p>903 EXT Vgain              50.00Hz              ▶ 97.1%              EXT 99.0%</p> </div>	<p>Set the voltage across terminals 2-5 to achieve 100%.</p>
<p>12) Apply a 5V voltage.</p>	<div style="border: 1px solid black; padding: 5px;"> <p>903 EXT Vgain              50.00Hz              ▶ 97.1%              EXT 99.0%</p> </div>	<p>..... In this example, 5V is applied as 50Hz is set for 5V input.</p>
<p>13) Press the <b>WRITE</b> key. The set value is stored into memory and gain setting is complete.</p>	<div style="border: 1px solid black; padding: 5px;"> <p>903 EXT Vgain              50.00Hz              99.6%              Completed</p> </div>	<p>The value displayed may not be just 100.0% in some cases. Setting is completed as shown below:</p>

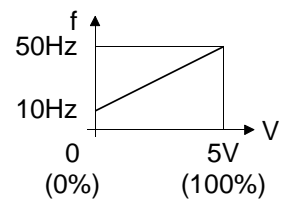

The adjustment of the frequency setting voltage bias and gain is completed.

**REMARKS**

1. The current input (Pr. 904, Pr. 905) can also be adjusted using a similar procedure.
2. The Pr. 903 (frequency setting gain) value remains unchanged if the Pr. 20 "acceleration/deceleration reference frequency" setting is changed.
3. A narrow calibration (command) value set using Pr. 902 and Pr. 903 (Pr. 904 and Pr. 905) will result in "Setting Error" and disable write.

**(3) Any point is adjusted without a voltage applied across terminals 2-5**

● Setting of the frequency setting voltage bias

<p>1) Press the <b>PU</b> key. The frequency setting screen appears.</p>	<pre>DIRECTLY Set    0.00Hz   ↓ 0~400</pre>
<p>2) Press the <b>SET</b> key. The parameter unit is put in the parameter setting mode.</p>	<pre>SETTING MODE Set Pr. NO. FOR PR. List &lt;HELP&gt;</pre>
<p>3) Type <b>9 0 2</b> with the number keys. The screen changes as shown on the right.</p>	<pre>SETTING MODE Pr. NO.       902 &lt;READ&gt;</pre>
<p>4) Press the <b>READ</b> key twice. The current Pr. 902 setting appears.</p>	<pre>902 EXTVbias   ↓    10.00Hz     -    0.5% EXT    20.0%</pre>
<p>5) Type <b>1 0</b> with the number keys. The screen changes as shown on the right.</p>	<pre>902 EXTVbias   ↓    10.00Hz     -    0.5% EXT -  20.0%</pre>
<p>6) Press the <b>WRITE</b> key. The cursor (▶) moves to the set voltage.</p>	<pre>902 EXTVbias   ↓    10.00Hz   ▶ -    0.5% EXT    20.0%</pre>
<p>7) Type <b>0</b> with the number key.</p>	<pre>902 EXTVbias   ↓    10.00Hz   ▶ -    0% EXT -  0.5%</pre>
<p>8) Press the <b>WRITE</b> key. The set value is stored into memory and bias setting is complete.</p>	<pre>902 EXTVbias   ↓    10.00Hz     -    0.0% Completed</pre>

The previous setting is displayed.  
The current set voltage across terminals 2-5 is displayed in %.  
When the set voltage is changed, the % value also changes.  
(The value selected in Pr. 73 (5V in this example) is 100%.)

..... Voltage need not be applied across terminals 2-5.

..... In this example, 0V is applied as 10Hz is set for 0V.

Setting is completed as shown below:

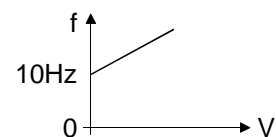

(Continued on the next page)

(From the preceding page)

● Setting of the frequency setting voltage gain

<p>9) Press the <b>SHIFT</b> key, then the <b>READ</b> key. The current Pr. 903 setting appears.</p>	<pre>903 EXTVgain   60.00Hz   97.1% EXT 99.0%</pre>	<p>The previous setting is displayed. The current set voltage across terminals 2-5 is displayed in %.</p>
<p>10) Type <b>5 0</b> with the number keys. The screen changes as shown on the right.</p>	<pre>903 EXTVgain   50.00Hz   97.1% EXT 99.0%</pre>	<p>When the set voltage is changed, the % value also changes. (The value selected in Pr. 73 (5V in this example) is 100%.)</p>
<p>11) Press the <b>WRITE</b> key. The cursor (<b>▶</b>) moves to the set voltage.</p>	<pre>903 EXTVgain   50.00Hz   97.1% EXT 99.0%</pre>	<p>..... Voltage need not be applied across terminals 2-5.</p>
<p>12) Type <b>1 0 0</b> with the number keys.</p>	<pre>903 EXTVgain   50.00Hz   - 100% EXT 99.0%</pre>	<p>..... In this example, 100% is input as 50Hz is set for 5V (100%).</p>
<p>13) Press the <b>WRITE</b> key. The set value is stored into memory and gain setting is complete.</p>	<pre>903 EXTVgain   50.00Hz   100% Completed</pre>	<p>Setting is completed as shown below:</p>

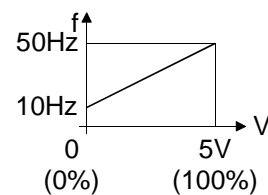

The adjustment of the frequency setting voltage bias and gain is completed.

**REMARKS**

1. The current input (Pr. 904, Pr. 905) can also be adjusted using a similar procedure.
2. The Pr. 903 (frequency setting gain) value remains unchanged if the Pr. 20 "acceleration/deceleration reference frequency" setting is changed.
3. A narrow calibration (command) value set using Pr. 902 and Pr. 903 (Pr. 904 and Pr. 905) will result in "Setting Error" and disable write.

## 2.6 Copy and Verify Functions

### 2.6.1 Copying the parameter settings

You can read and store parameter settings into the FR-PU04. You can also copy the stored parameter settings to another inverter of the same series and same capacity.

#### <Precautions for setting>

- Select the PU operation mode.
- Use these functions after stopping the inverter.
- Parameter values cannot be copied when you have set "1" in Pr. 77 "parameter write inhibit selection" of the copy destination inverter to inhibit parameter write.
- Copy/verify cannot be performed between different inverter series.
- Reading the parameter settings

<p>1) Connect the FR-PU04 to the inverter. 2) Press the <b>SET</b> key. This selects the setting mode.</p>	<div style="border: 1px solid black; padding: 5px;">             SETTING MODE              Set Pr. NO              Pr. List →HELP              Pr. COPY → ▲           </div>
<p>3) Press the <b>▲</b> key. The parameter unit enters the ROM batch mode.</p>	<div style="border: 1px solid black; padding: 5px;">             ALL Pr. S              READ ↕ &lt;READ&gt;              WRITE ↕ &lt;WRITE&gt;              VER ↕ ▼           </div>
<p>4) Press the <b>READ</b> key. The inverter's parameter settings are stored.</p>	<div style="border: 1px solid black; padding: 5px;">             ALL Pr. S  <div style="background-color: black; color: white; padding: 2px;">Reading Completed</div> </div>

#### ● Writing the parameter settings

<p>1) Connect the FR-PU04 to the inverter. 2) Press the <b>SET</b> key. This selects the setting mode.</p>	<div style="border: 1px solid black; padding: 5px;">             SETTING MODE              Set Pr. NO              Pr. List →HELP              Pr. COPY → ▲           </div>
<p>3) Press the <b>▲</b> key. The parameter unit goes into the ROM batch mode.</p>	<div style="border: 1px solid black; padding: 5px;">             ALL Pr. S              READ ↕ &lt;READ&gt;              WRITE ↕ &lt;WRITE&gt;              VER ↕ ▼           </div>
<p>4) Press the <b>WRITE</b> key. The parameter settings stored in the FR-PU04 are copied to the copy destination inverter.</p>	<div style="border: 1px solid black; padding: 5px;">             ALL Pr. S              Writing  <div style="background-color: black; color: white; padding: 2px;">Completed</div>             Please Reset           </div>
<p>5) Reset the inverter.</p>	

#### CAUTION

1. Note that all data stored in the parameter unit is updated when read is performed from the inverter.
2. Exercise care not to switch power off while parameters are being written.

#### REMARKS

1. Write cannot be performed while the inverter is running. Read and verify can be performed during running.
2. Read and write cannot be stopped partway through the operation.
3. If power is switched off, parameter data stored in the parameter unit remains unerased. Therefore, a backup power supply is not needed.

## 2.6.2 Verifying the parameters

### ● Verify

<p>1) Connect the FR-PU04 to the inverter.                  2) Press the <b>(SET)</b> key. This selects the setting mode.</p>	<div style="border: 1px solid black; padding: 5px;">                     SETTING MODE                      Set Pr. NO                      Pr. List →HELP                      Pr. COPY→ ▲                 </div>
<p>3) Press the <b>(▲)</b> key.                  The parameter unit enters the ROM batch mode.</p>	<div style="border: 1px solid black; padding: 5px;">                     ALL Pr. S                      READ ▶ &lt;READ&gt;                      WRITE ▶ &lt;WRITE&gt;                      VER ▶ ▼                 </div>
<p>4) Press the <b>(▼)</b> key.                  The parameter settings stored in the FR-PU04 are verified with those of the inverter. (If an error is detected during verify, the corresponding Pr. is shown.)                  However, if an incorrect value has been entered directly (f setting) or set in any of Pr. 173 to Pr. 175 and Pr. 199 (*), only "Verify Err" will be displayed.                  *Pr. 173 to Pr. 175 and Pr. 179 are parameters for the FR-A500 / F500 series.</p>	<div style="border: 1px solid black; padding: 5px;">                     ALL Pr. S                       Verifying                      Completed                 </div>

Press the **(0)** key when you want to continue verify with "Verify Err" displayed.

# CHAPTER 3

# HELP

This chapter explains the  key in the use of this product.

Always read the instructions before using the equipment.

3.1 Overview of the Help Functions .....	32
3.2 Operation Procedures for the Help Functions .....	36
3.3 Other Precautions .....	53

Chapter 1

Chapter 2

Chapter 3

Chapter 4

Chapter 5

# 3.1 Overview of the Help Functions

Press the (HELP) key twice in any operation mode to call the help function menu, on which you can perform various functions.

● Menu screen page 1 ● Menu screen page 2 ● Menu screen page 3

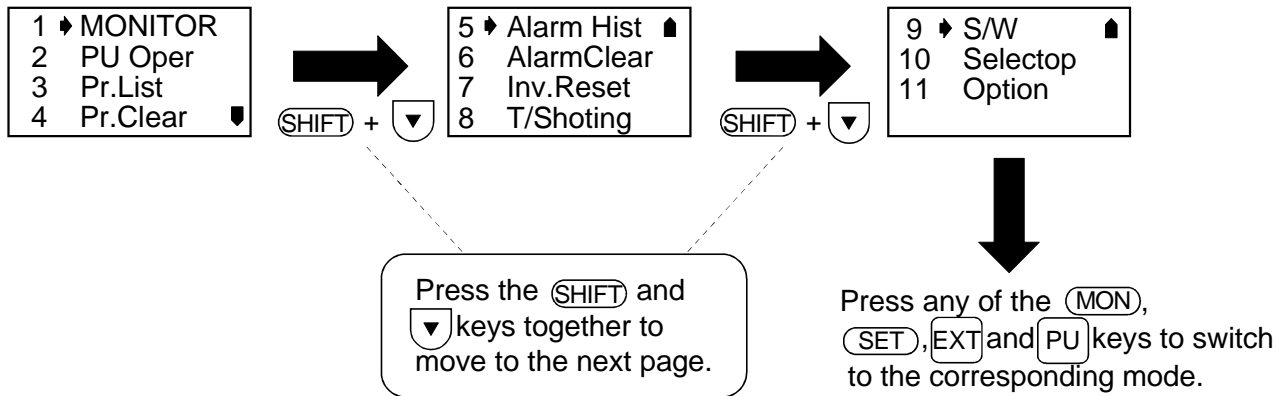

## 3.1.1 Help function menu

**REMARKS**

The functions vary with the inverter model and may be invalid for some inverters.

Help Menu	Description	Refer To
1. MONITOR	The monitor list appears, and you can change from one screen to another and set the first priority screen.	Page 36
2. PU Oper	You can select the PU operation mode via direct input (direct setting with the number keys) or select the jog operation mode from the PU, and displays how to operate the keys.	Page 38
3. Pr. List	The parameter menu appears, and you can perform "parameter setting", "list display", "change list display", "initial value list display" and "user's initial value setting list display".	Page 40
4. Pr. Clear	The parameter clear menu appears, and you can perform "parameter clear", "all clear", "user clear" and "no clear".	Page 43
5. Alarm Hist	Shows the history of past faults (alarms).	Page 44
6. Alarm Clear	Clears all the fault (alarm) history.	Page 45
7. Inv. Reset	Resets the inverter.	Page 46
8. T/Shoting	The inverter displays the cause of mismatch between inverter operation and control/setting or the cause of an inverter fault.	Page 47
9. S/W	Shows the software control number of the inverter.	—
10. Selectop	Shows the signals assigned to the I/O terminals of the control circuit and the ON-OFF states of the signals.	Page 51
11. Option	Shows the option fitting states of the option connectors 1 to 3.	Page 52

### 3.1.2 Help function display data

#### CAUTION

The functions vary with the inverter.

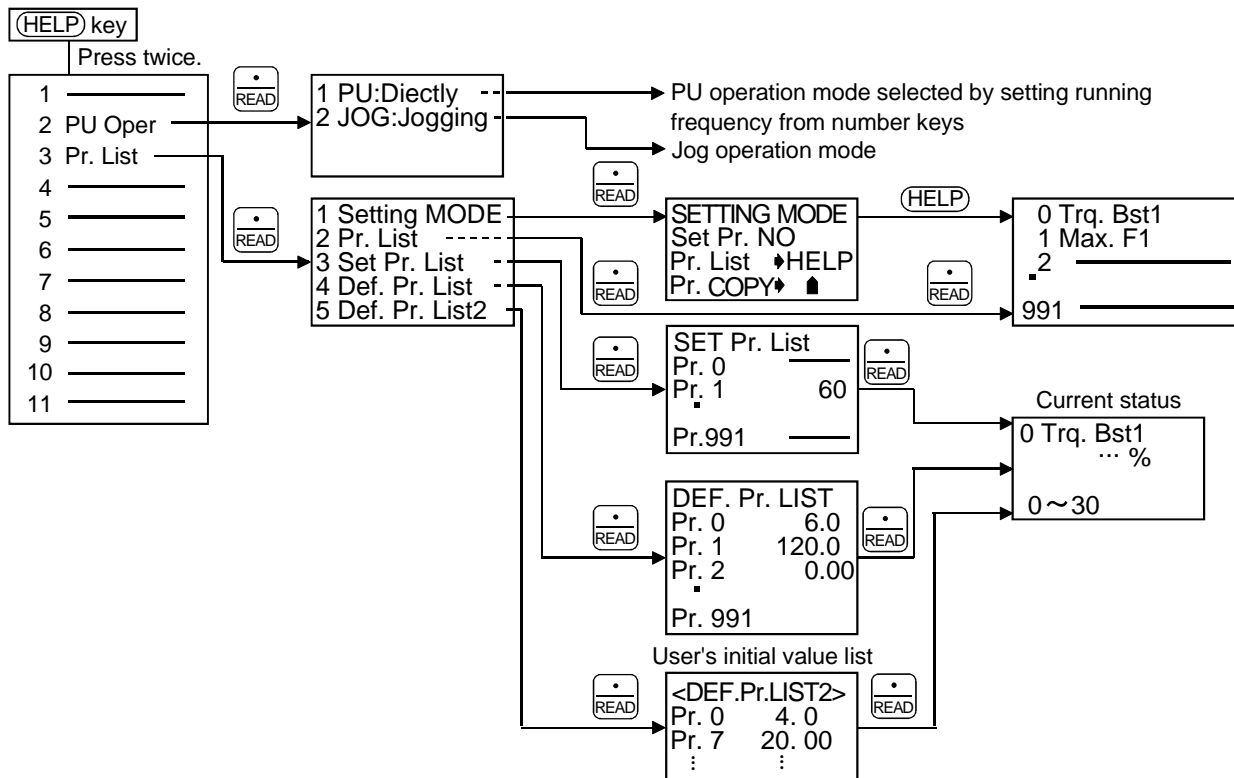
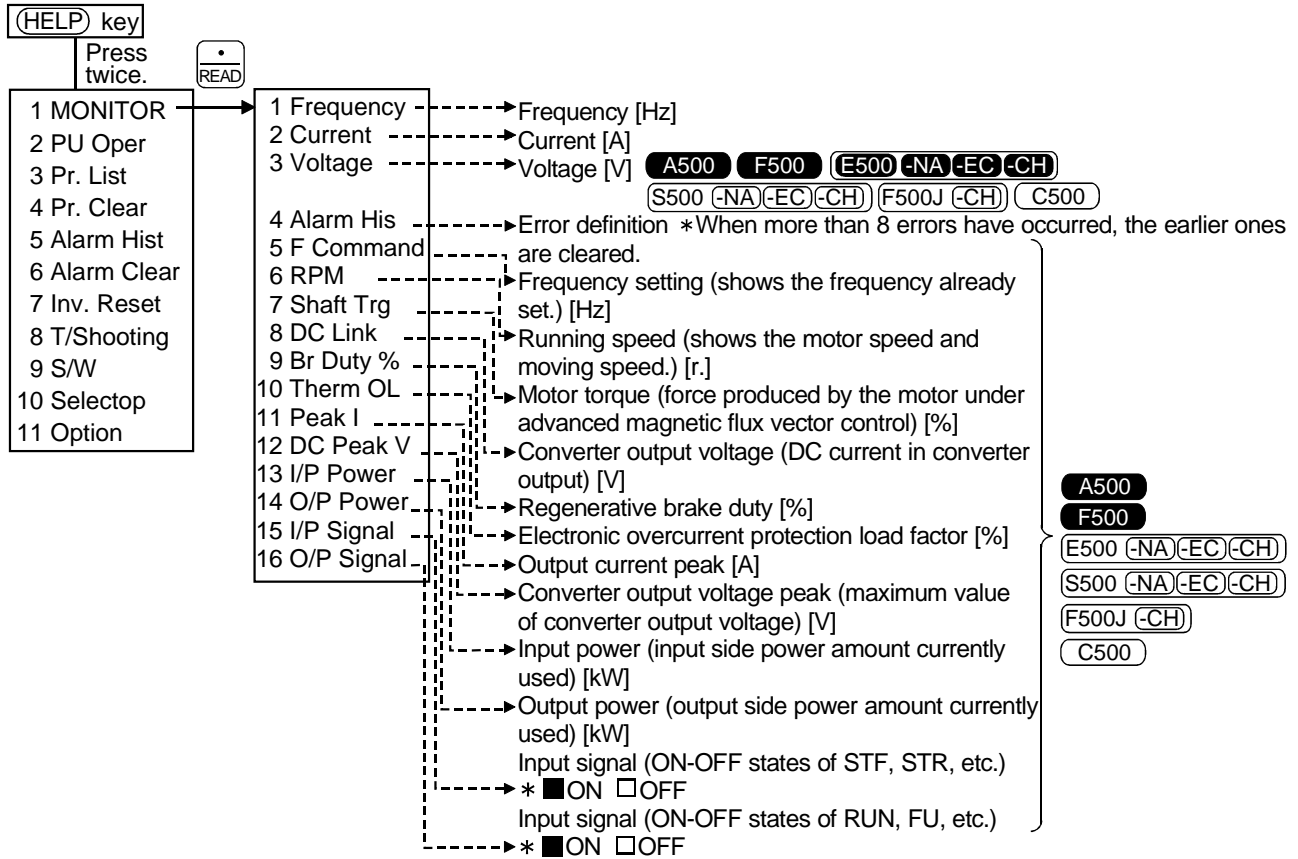



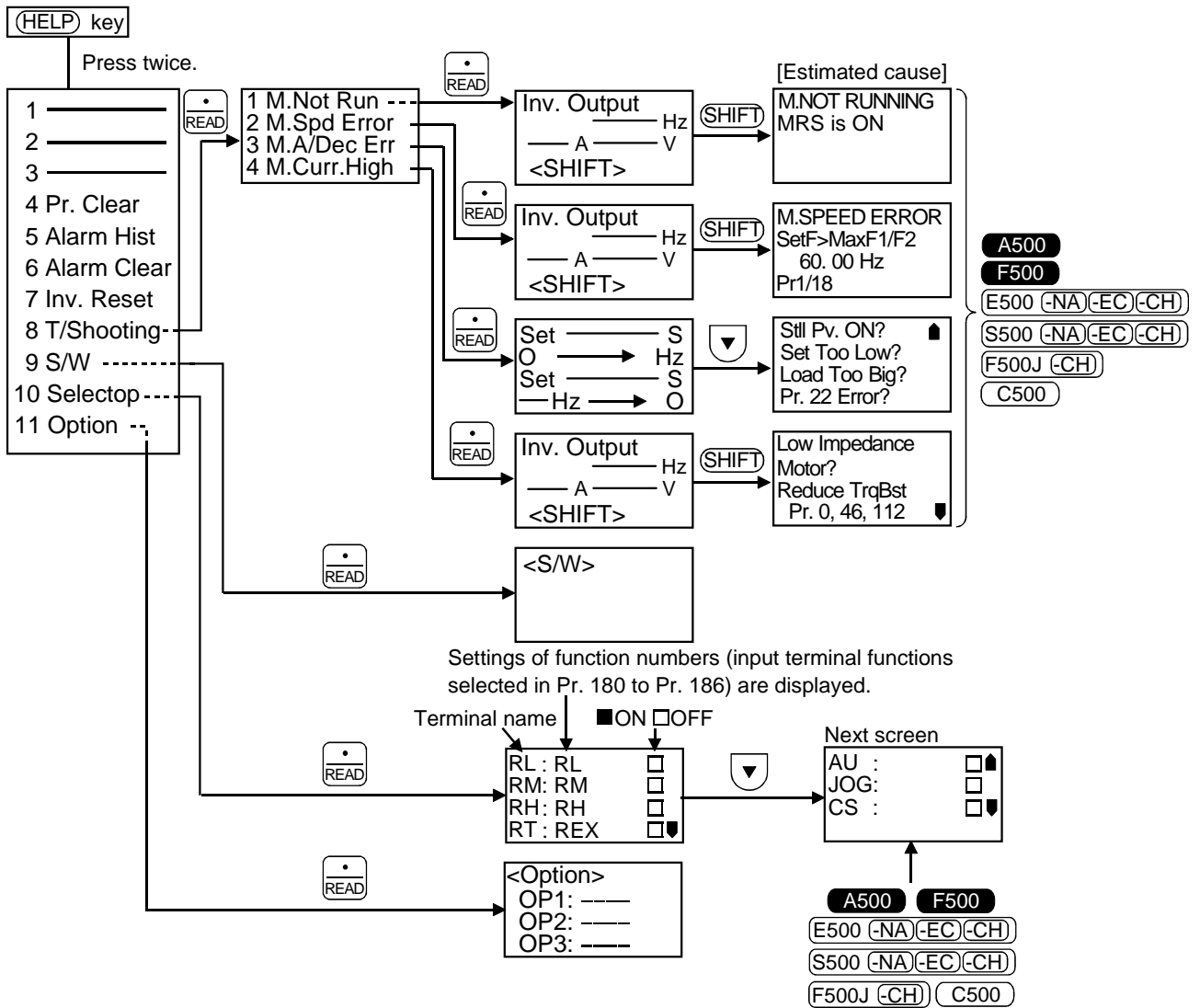

## 3.2 Operation Procedures for the Help Functions

HELP



### CAUTION

The functions vary with the inverter.

### 3.2.1 Monitor function

The monitoring list appears and you can change from one monitor screen to another and set the first priority screen.

#### ● To call the monitoring list from the help function menu

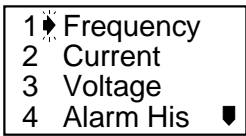
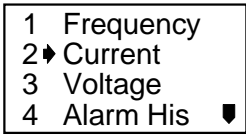
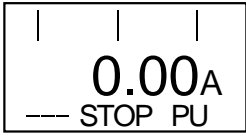
<p>1) Press the <b>HELP</b> key twice in the monitoring mode. The help function menu is called.</p>	
<p>2) Make sure that the cursor (▶) is located at "1 MONITOR". If not, move the cursor with the <b>▲</b>/<b>▼</b> key.</p>	
<p>3) Press the <b>READ</b> key. The monitoring list is called.</p>	
<p>4) Press the <b>▲</b> or <b>▼</b> key to move the cursor to the required item.</p> <p><b>REMARKS</b> If the required item is not found, press the <b>SHIFT</b> key and <b>▼</b> key together to shift to the next page.</p>	
<p>5) Press the <b>READ</b> key. The monitor screen indicated by the cursor appears. Press the <b>WRITE</b> key to give the first priority to this monitor screen.</p>	

### ● To call the monitoring list directly in the monitoring mode

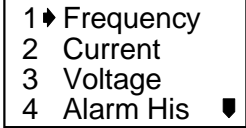
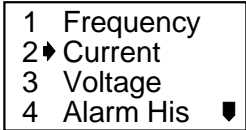
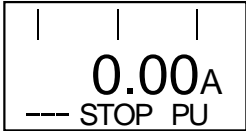
<p>1) Press the <b>(MON)</b> key. The parameter unit is put in the monitoring mode. (You need not press this key when the parameter unit is already in the monitoring mode.)</p>	
<p>2) Press the <b>(HELP)</b> key. The monitoring list is called.</p>	
<p>3) Press the <b>(▲)</b> or <b>(▼)</b> key to move the cursor to the required item.</p> <p><b>REMARKS</b> If the required item is not found, press the <b>(SHIFT)</b> key and <b>(▼)</b> key together to shift to the next page.</p>	
<p>4) Press the <b>(READ)</b> key. The monitor screen indicated by the cursor appears. Press the <b>(WRITE)</b> key to give the first priority to this monitor screen.</p>	

### 3.2.2 Selection of PU operation (direct input)

You can select the PU operation mode via direct input (direct setting from the ten digits key pad) or select the jog operation mode from the PU and show how to operate the keys.

#### ● Calling from the help function menu

1) Press the <b>(HELP)</b> key twice in the monitoring mode. The help function menu is called.	<pre>1 ▶ MONITOR 2  PU Oper 3  Pr. List 4  Pr. Clear ▼</pre>
2) Using the <b>▼</b> key, move the cursor to "2 PU Operation".	<pre>1  MONITOR 2 ▶ PU Oper 3  Pr. List 4  Pr. Clear ▼</pre>
3) Press the <b>READ</b> key. The menu on the right appears.	<pre>1 ▶ PU : Directly 2  JOG : Jogging</pre>
4) Make sure that the cursor is located at "1 PU: Directly". If not, move the cursor with the <b>▲/▼</b> key.	<pre>1 ▶ PU : Directly 2  JOG : Jogging</pre>
5) Press the <b>READ</b> key. The PU operation mode is selected and the frequency setting screen appears.	<pre>DIRECTLY Set      0.00Hz ▶</pre>
6) Press the <b>(HELP)</b> key. The key operation guide appears.	<pre>KEY OPERATION Fset : 0~9 Then : WRITE Then : FWD,REV</pre>

#### ● To call the key operation guide directly

1) Press the <b>PU</b> key. The frequency setting screen appears.	<pre>DIRECTLY Set      0.00Hz ▶</pre>
2) Press the <b>(HELP)</b> key. The key operation guide appears.	<pre>KEY OPERATION Fset : 0~9 Then : WRITE Then : FWD,REV</pre>

### 3.2.3 Selection of the PU jog operation mode

**A500** **F500** **E500-NA-EC-CH** **S500-NA-EC-CH** **F500J-CH** **C500**

#### (1) Calling from the help function menu

1) Press the <b>HELP</b> key twice in the monitoring mode. The help function menu is called.	<pre> 1 ▶ MONITOR 2  PU Oper 3  Pr. List 4  Pr. Clear ▼ </pre>
2) Using the <b>▼</b> key, move the cursor to "2 PU Operation".	<pre> 1  MONITOR 2 ▶ PU Oper 3  Pr. List 4  Pr. Clear ▼ </pre>
3) Press the <b>READ</b> key. The menu on the right appears.	<pre> 1 ▶ PU : Directly 2  JOG : Jogging </pre>
4) Using the <b>▼</b> key, move the cursor to "2 JOG: Jogging".	<pre> 1  PU : Directly 2 ▶ JOG : Jogging </pre>
5) Press the <b>READ</b> key. The PU jog operation mode is selected and the frequency setting screen appears.	<pre>           PU/JOG Set      5. 00Hz ▶ </pre>
6) Press the <b>HELP</b> key. The key operation guide is displayed.	<pre> KEY OPERATION Fset : 0~9 Then : WRITE Then : FWD,REV </pre>

#### (2) Calling the key operation guide directly









1) Press the <b>PU</b> key. The frequency setting screen appears.	<pre> DIRECTLY Set      0. 00Hz ▶ </pre>
2) Press the <b>SHIFT</b> key. The PU jog operation mode is selected and the frequency setting screen appears.	<pre>           PU/JOG Set      5. 00Hz ▶ </pre>
3) Press the <b>HELP</b> key. The key operation guide appears.	<pre> KEY OPERATION Fset : 0~9 Then : WRITE Then : FWD,REV </pre>

### 3.2.4 Parameters







The parameter menu is displayed and you can select and perform any of the following operations:

- **Setting:** ..... Switches to the parameter setting mode.
- (1) **Pr. List:**..... Lists the parameters in numerical order so that you can read and write individual parameter values.
- (2) **Set Pr. List:** ..... Lists only the parameters whose factory settings have been changed, together with their Pr. numbers. (For parameters whose factory settings remain unchanged, their Pr. numbers are only displayed.)
- (3) **Def. Pr. List:** ..... Lists the initial values (default factory settings) of parameters.
- (4) **Def. Pr. List 2:** ..... Lists user's initial values (settings of parameters selected in Pr. 199) of parameters.

#### ● Parameter "Setting"

1) Press the  key twice in the monitoring mode. The help function menu is called.	<div style="border: 1px solid black; padding: 5px;">             1  MONITOR              2 PU Oper              3 Pr. List              4 Pr. Clear  </div>
2) Using the  key, move the cursor to "3 Pr. List".	<div style="border: 1px solid black; padding: 5px;">             1 MONITOR              2 PU Oper              3  Pr. List              4 Pr. Clear  </div>
3) Press the  key. The parameter menu appears.	<div style="border: 1px solid black; padding: 5px;">             1  SettingMODE              2 Pr. List              3 Set Pr. List              4 Def. Pr. List           </div>
4) Press the  key. The parameter unit switches to the setting mode. Refer to the parameter setting method on page 13.	<div style="border: 1px solid black; padding: 5px;">             SETTING MODE              Set Pr. NO.              FOR Pr.List              &lt;HELP&gt;           </div>

**(1) "2 Pr. List"**

1) Refer to page 40 and call the parameter menu.	<div style="border: 1px solid black; padding: 5px;"> 1 ▶ SettingMODE  2 Pr. List  3 Set Pr. List  4 Def. Pr. List </div>
2) Using the  key, move the cursor to "2 Pr. List".	<div style="border: 1px solid black; padding: 5px;"> 1 SettingMODE  2 ▶ Pr. List  3 Set Pr. List  4 Def. Pr. List </div>
3) Press the  key. The parameter list is displayed.	<div style="border: 1px solid black; padding: 5px;"> 1 ▶ Trq. Bst1  2 Max. F1  3 Min. F1  4 VFbaseF1 ▾ </div>
4) Press the  or  key to move the cursor to the required item.	<div style="border: 1px solid black; padding: 5px;"> 1 ▶ Trq. Bst1  2 Max. F1  3 Min. F1  4 VFbaseF1 ▾ </div>
5) If the required item is not found, press the  key and  key together to shift to the next page.	
6) Press the  key. The parameter indicated by the cursor is read and the parameter unit enters the parameter setting mode.	<div style="border: 1px solid black; padding: 5px;"> 0 Trq. Bst1  6.0%  ▶ </div>

Press the  key to move to the next parameter.

**(2) Display of "3 Set Pr. List"**

**A500** **F500** E500 (-NA) (-EC) (-CH) S500 (-NA) (-EC) (-CH) F500J (-CH) C500

- When the parameter setting has been changed from the factory setting, the new value is displayed.

"-" is displayed when the parameter setting has not been changed from the factory setting.

The parameters are displayed in numerical order, starting with No. 0.

**(3) Display of "4 Def. Pr. List"**

**A500** **F500** E500 (-NA) (-EC) (-CH) S500 (-NA) (-EC) (-CH) F500J (-CH) C500





The factory settings of the parameters are displayed.

**(4) Display of "5 Def. Pr. List 2"**

**A500** **F500** E500 (-NA) (-EC) (-CH) S500 (-NA) (-EC) (-CH) F500J (-CH) C500

The parameter numbers already registered to Pr. 199 "user's initial value setting" and their values are displayed.

When no registration has been made, "No Changes" appears.

1) Refer to page 40 and call the parameter menu.	<div style="border: 1px solid black; padding: 5px;">           1 ▶ SettingMODE            2 Pr. List            3 Set Pr. List            4 Def. Pr. List         </div>
2) Using the  key, move the cursor to "3 Set Pr. List".	<div style="border: 1px solid black; padding: 5px;">           1 SettingMODE            2 Pr. List            3 ▶ Set Pr. List            4 Def. Pr. List         </div>
3) Press the  key. The SET Pr. LIST appears. Press the  key and  key together to move to the next page.	<div style="border: 1px solid black; padding: 5px;">           Set Pr. LIST            Pr 0 ▶ 8.0            Pr 1 —            Pr 2 —         </div>

To call the Def. Pr. List or Def. Pr. List 2, move the cursor to "4 Def. Pr. List" or "5 Def. Pr. List 2" in above step 2.

### 3.2.5 Parameter Clear

The parameter clear menu appears and you can select and perform any of the following four operations:

Switch to the PU operation mode before performing any operation.

(1) Clear Pr.:..... Returns (initializes) the parameters to the factory settings with the exception of the some parameters (Pr. 75 and calibration values in Pr. 900 to 905).

(2) Clear All: ..... Initializes all parameters with the exception of Pr. 75.

(3) Clear User:..... **A500** **F500** **E500** **-NA** **-EC** **-CH** **S500** **-NA** **-EC** **-CH**  
**F500J** **-CH** **C500**

Returns the parameters registered for user's initial values in Pr. 199 to the user's initial values and the other parameters to the factory settings.

(4) Clear None:..... Does not initialize.

#### ● Parameter clear

<p>1) Press the <b>HELP</b> key twice in the operation mode. The help function menu is called.</p>	<pre>1 ♦ SettingMODE 2 Pr. List 3 Set Pr. List 4 Def. Pr. List</pre>
<p>2) Using the <b>▼</b> key, move the cursor to "4 Pr. Clear".</p>	<pre>1 SettingMODE 2 Pr. List 3 Set Pr. List 4 ♦ Def. Pr. List</pre>
<p>3) Press the <b>READ</b> key. The parameter clear menu appears.</p>	<pre>1 ♦ Clear Pr. 2 Clear All 3 Clear User 4 Clear None</pre>
<p>4) Press the <b>READ</b> key. The screen changes as shown on the right.</p>	<pre>Clear Pr. Exec &lt;WRITE&gt; Cancel&lt;ESC&gt;</pre>
<p>5) Press the <b>WRITE</b> key. (*) The screen changes as shown on the right and the parameters are initialized.</p>	<pre>Clear Pr. <b>Executing</b></pre>

To execute Clear All or Clear User, move the cursor to "2 Clear All" or "3 Clear User" in above step 3.

\*When you pressthe **ESC** key, the clear operation is not performed.

### 3.2.6 Alarm History

Shows the history of eight past alarms. (\*1)

<p>1) Press the <b>HELP</b> key twice in the operation mode. The help function menu is called.</p>	<div style="border: 1px solid black; padding: 5px;"> <p>1 ▶ MONITOR 2 PU Oper 3 Pr. List 4 Pr. Clear ▼</p> </div>
<p>2) Press the <b>SHIFT</b> key and <b>▼</b> key together. The screen moves to the next page.</p>	<div style="border: 1px solid black; padding: 5px;"> <p>5 ▶ Alarm Hist ▲ 6 AlarmClear 7 Inv. Reset 8 T/Shooting</p> </div>
<p>3) Make sure that the cursor is located at "5 Alarm Hist". If not, move the cursor with the <b>▲/▼</b> key.</p>	<div style="border: 1px solid black; padding: 5px;"> <p>5 ▶ Alarm Hist ▲ 6 AlarmClear 7 Inv. Reset 8 T/Shooting</p> </div>
<p>4) Press the <b>READ</b> key. The alarm history appears.</p>	<div style="border: 1px solid black; padding: 5px;"> <p>1 OV3 5 UVT 2 UVT 6 3 UVT 7 4 UVT 8</p> </div>
<p>5) Press the <b>READ</b> key. The running frequency at alarm occurrence is displayed.</p>	<div style="border: 1px solid black; padding: 5px;"> <p>Latest Error  OV During Dec 30.00Hz ▼</p> </div>
<p>6) Press the <b>▼</b> key. The voltage/current application time (Note) at alarm occurrence is displayed.</p>	<div style="border: 1px solid black; padding: 5px;"> <p>Latest Error ▲ 17.5A 220.0V 6000hr</p> </div>

To display the second or earlier past failure monitor, press the **READ** key in step 5 above.

\*1 For the FR-S500 series, four past alarms are displayed.

\*2 The energization time is displayed only for the FR-A500 / F500 series. For other inverters, "0" is always displayed.

### 3.2.7 Alarm Clear

Clears all the alarm history.

<p>1) Press the <b>HELP</b> key twice in the operation mode. The help function menu is called.</p>	<pre> 1 ▶ MONITOR 2  PU Oper 3  Pr. List 4  Pr. Clear ▼           </pre>
<p>2) Press the <b>SHIFT</b> key and <b>▼</b> key together. The screen moves to the next page.</p>	<pre> 5 ▶ Alarm Hist ▲ 6  AlarmClear 7  Inv. Reset 8  T/Shooting           </pre>
<p>3) Using the <b>▼</b> key, move the cursor to "6 Alarm Clear".</p>	<pre> 5  Alarm Hist ▲ 6 ▶ AlarmClear 7  Inv. Reset 8  T/Shooting           </pre>
<p>4) Press the <b>READ</b> key.</p>	<pre> Alarm Clear Exec &lt;WRITE&gt; Cancel&lt;ESC&gt;           </pre>
<p>5) Press the <b>WRITE</b> key. (*) The screen changes as shown on the right and the alarm history is cleared.</p>	<pre> ALARM CLEAR  Completed           </pre>

\*When you press the **ESC** key, the alarm history clear operation is not performed.

### 3.2.8 Inverter Reset

Resets the inverter.

<p>1) Press the <b>HELP</b> key twice in the operation mode. The help function menu is called.</p>	<pre> 1 ▶ MONITOR 2  PU Oper 3  Pr. List 4  Pr. Clear ▼           </pre>
<p>2) Press the <b>SHIFT</b> key and <b>▼</b> key together. The screen moves to the next page.</p>	<pre> 5 ▶ Alarm Hist ▲ 6  AlarmClear 7  Inv. Reset 8  T/Shooting           </pre>
<p>3) Using the <b>▼</b> key, move the cursor to "7 Inv. Reset".</p>	<pre> 5  Alarm Hist ▲ 6  AlarmClear 7 ▶ Inv. Reset 8  T/Shooting           </pre>
<p>4) Press the <b>READ</b> key. The screen changes as shown on the right.</p>	<pre> Inv. RESET Exec &lt;WRITE&gt; Cancel&lt;ESC&gt;           </pre>
<p>5) Press the <b>WRITE</b> key. (*) The inverter is reset and the parameter unit switches to the monitoring mode.</p>	<pre>       0.00Hz --- STOP EXT           </pre>

\* When you press the **ESC** key, the inverter is not reset and the parameter unit switches to the monitoring mode.

A similar reset operation may also be performed by switching power "off" or by switching the RES signal on. If the inverter's protective function is activated to bring the inverter to an alarm stop (output shutoff), the alarm stop state may be canceled by pressing the **STOP/RESET** key without performing the above operation.

### 3.2.9 Troubleshooting

**A500** **F500** E500 (-NA) (-EC) (-CH) S500 (-NA) (-EC) (-CH) F500J (-CH) C500

If the inverter appears to operate improperly, perform the following operation to display the most likely cause of the fault.

This operation may also be performed during inverter operation (PU operation, external operation) or during alarm trip (protection activated).

1) Press the <b>HELP</b> key twice in the operation mode. The help function menu is called.	<div style="border: 1px solid black; padding: 5px;">             1 <b>MONITOR</b>              2 PU Oper              3 Pr. List              4 Pr. Clear <b>▼</b> </div>
2) Press the <b>SHIFT</b> key and <b>▼</b> key together. The screen moves to the next page.	<div style="border: 1px solid black; padding: 5px;">             5 <b>Alarm Hist</b> <b>▲</b>              6 AlarmClear              7 Inv. Reset              8 T/Shooting           </div>
3) Using the <b>▼</b> key, move the cursor to "8 T/Shooting".	<div style="border: 1px solid black; padding: 5px;">             5 Alarm Hist <b>▲</b>              6 AlarmClear              7 Inv. Reset              8 <b>T/Shooting</b> </div>
4) Press the <b>READ</b> key. The alarm phenomenon menu appears.	<div style="border: 1px solid black; padding: 5px;">             1 <b>M. Not Run</b>              2 M. Spd Error              3 M. A/Dec Err              4 M. Curr.High           </div>
5) Press the <b>▲</b> or <b>▼</b> key to move the cursor to the required item.	<div style="border: 1px solid black; padding: 5px;">             1 M. Not Run              2 <b>M. Spd Error</b>              3 M. A/Dec Err              4 M. Curr.High           </div>
6) Press the <b>READ</b> key. The cause of the fault is displayed. (See page 48.)	<div style="border: 1px solid black; padding: 5px;"> <b>M. SPEED ERROR</b>              SetF&gt;MaxF1/F2              60.00 Pr1/18              Hz           </div>

## (1) Troubleshooting guidance

### 1) M.NOT RUNNING (Motor does not run)

M. NOT RUNNING ALARM Indicated <SHIFT>	The inverter has alarm-tripped (protection activated), resulting in output shut-off. Press the <b>(SHIFT)</b> key to display the cause of the trip.	M. NOT RUNNING Max. F1<StartF Pr. 1 Pr. 13	The inverter cannot start because the inverter starting frequency (Pr. 13) is higher than the maximum frequency (Pr. 1).
M. NOT RUNNING NO I/P Power or Phase Loss	The inverter's main circuit power is lost or there is an open phase in the power supply. Check the power supply.	M. NOT RUNNING EnableFR Set See Pr. 78	The inverter cannot start because you attempted to run the motor in the direction in which forward or reverse rotation is inhibited as set in Pr. 78.
M. NOT RUNNING STF, STR both are OFF or ON	Both start signals STF and STR are ON or OFF.	M. NOT RUNNING Current Limit Activated <SHIFT>	The inverter cannot start since the current limit function is activated. Press the <b>(SHIFT)</b> key to display the estimated cause that the current limit function was activated.
M. NOT RUNNING MRS is ON	The output shut-off input signal MRS is ON.	M. NOT RUNNING TS Control Standby Mode	The inverter does not start because it is in a stop period in the programmed operation mode.
M. NOT RUNNING SetF<StartF Pr. 13	The inverter starting frequency (Pr. 13) setting is higher than the frequency currently set.	M. NOT RUNNING Under PID Control	The inverter does not start because the inverter need not start the motor as a result of the arithmetic operation of PID control.
M. NOT RUNNING AU is OFF	The current input select signal AU remains OFF (not ON).	M. NOT RUNNING CS is OFF See Pr. 57	The inverter will not restart since the automatic restart after instantaneous power failure select signal CS is OFF.
M. NOT RUNNING NO Command From PU	Neither of the FWD and REV keys are ON in the PU operation mode.		It is estimated that an instantaneous power failure has occurred or the inverter in the commercial power supply switch-over operation mode.

## 2) M.SPEED ERROR

(Speed does not match the running frequency setting)

M. SPEED ERROR  
SetF>MaxF1/F2  
60.00 Hz  
Pr1/18

Since the running frequency setting is higher than the maximum frequency (Pr. 1) setting, the running frequency remains at the maximum frequency.

M. SPEED ERROR  
SetF<MinF1  
60.00 Hz  
Pr2

Since the running frequency setting is lower than the minimum frequency (Pr. 2) setting, the running frequency has been increased to the minimum frequency.

M. SPEED ERROR  
Fjump Working  
See Pr. 31▶36  
SetF= 60.00Hz

Since the running frequency setting is within the frequency jump setting range (Pr. 31 to 36), the running frequency has jumped.

M. SPEED ERROR  
Current Limit  
Activated  
<SHIFT>

The current limit function was activated and forced the running frequency to reduce. Press the (SHIFT) key to display the cause that the current limit function was activated.

M. SPEED ERROR  
Under  
PI▶Control

As a result of arithmetic operation of PID control, the running frequency differs from the set value.

## 3) M.A/Dec Err

(Actual acceleration/deceleration time is longer than the Pr. 7/Pr. 8 setting)

Set 5.0S  
0▶60.00Hz  
Set 5.0S  
60.00Hz▶0

Acceleration time setting (Pr. 7) is displayed.

Frequency reached in the above set time (acceleration/deceleration reference frequency, Pr. 20) is displayed.

Deceleration time setting (Pr. 8) is displayed.

Frequency from which deceleration is made in the above set time (acceleration/deceleration reference frequency, Pr. 20) is displayed.



Still Pv. ON?

Set Too Low?

Load Too Big?

Pr. 22 Error?

Estimated cause that actual acceleration/deceleration time is longer than the setting is displayed.

## 4) M.Curr.High

(Inverter output current is larger than normal)

Inv. Output  
60.00Hz  
10A 182.4V  
<SHIFT>

First, the running frequency, output current and output voltage of the inverter are displayed. Press the **(SHIFT)** key to display the estimated cause of large output current.

(SHIFT)

Low Impedance  
Motor?  
Reduce TrqBst  
Pr. 0, 46, 112

The motor used may be a special motor other than the general-purpose 3-phase induction motor. If so, reduce the torque boost setting. Related parameters: Pr. 0, 46, 112

▲ ▼

Low Trq  
Motor?  
Reduce TrqBst  
Pr. 0, 46, 112

The motor used may be a constant-torque motor (motor for inverter). If so, reduce the torque boost setting. Related parameters: Pr. 0, 46, 112

▲ ▼

Trq. Bst  
Setting Err?  
See Pr. 0, 46,  
112

Since the torque boost setting may be inappropriate, check the following relevant parameters: Related parameters: Pr. 0, 46, 112

▲ ▼

V/F Setting  
Error?  
See Pr. 3, 14,  
19, 47

Since the V/F pattern setting may be inappropriate, check the following relevant parameters: Related parameters: Pr. 3, 14, 19, 47

▲ ▼

Load Too Big?  
OutPut  
Phase Loss?

The load may be too heavy. An open phase may have occurred between the inverter and motor.

### 3.2.10 Selectop

**A500** **F500** E500 (-NA) (-EC) (-CH) S500 (-NA) (-EC) (-CH) F500J (-CH) C500











Displays the signals assigned to the I/O terminals of the control circuit and their ON-OFF states.

<p>1) Press the <b>(HELP)</b> key twice in the operation mode. The help function menu is called.</p>	<pre> 1 ▶ MONITOR 2 PU Oper 3 Pr. List 4 Pr. Clear ▼           </pre>
<p>2) Press the <b>(SHIFT)</b> key and <b>(▼)</b> key together twice. The screen moves two pages.</p>	<pre> 9 ▶ S/W ▲ 10 Selectop 11 Option           </pre>
<p>3) Using the <b>(▼)</b> key, move the cursor to "10".</p>	<pre> 9 S/W ▲ 10 ▶ Selectop 11 Option           </pre>
<p>4) Press the <b>(READ)</b> key. The signals assigned to the control circuit terminals and their ON-OFF states are displayed. (*)</p>	<pre> RL : 0   ■ RM : 1   □ RH : 2   □ RT : 3   □▼           </pre>

\*The screen shows "- - -" when you set "9999" in Pr. 180 to Pr. 186.

### 3.2.11 Option

Displays what options are fitted to the option connectors.

<p>1) Press the  key twice in the operation mode. The help function menu is called.</p>	<div style="border: 1px solid black; padding: 5px;"> <p>1  MONITOR 2 PU Oper 3 Pr. List 4 Pr. Clear </p> </div>
<p>2) Press the  key and  key together twice. The screen moves two pages.</p>	<div style="border: 1px solid black; padding: 5px;"> <p>9  S/W  10 Selectop 11 Option</p> </div>
<p>3) Using the  key, move the cursor to "11".</p>	<div style="border: 1px solid black; padding: 5px;"> <p>9 S/W  10 Selectop 11  Option</p> </div>
<p>4) Press the  key. What options are mounted are displayed. (*)</p>	<div style="border: 1px solid black; padding: 5px;"> <p>&lt;Option&gt; OP1 : --- OP2 : --- OP3 : ---</p> </div>

\*Numbers OP1 to OP3 correspond to numbers 1 to 3 of the option slot on the inverter side.

For the inverter with only one option slot, what option is mounted is displayed next to OP1.

## 3.3 Other Precautions

### 3.3.1 Precautions for parameter unit operation

Note the following items when operating the parameter unit to prevent setting from being disabled or incorrect values from being entered.

#### (1) Precautions for the digit count and decimal point of input value

- The maximum number of input digits is 5. If you enter a value in excess of 5 digits, the most significant digit is ignored.

12345.6 → ■ 2345.6  
(Input)           ↑ Ignored

#### (2) Other indications

- When the input power is switched on (or the inverter is reset), the message below will be displayed. It is displayed while the inverter and parameter unit are making communication checks mutually, and is not a fault.  
However, if that message does not disappear in about 1 minute, perform the following check.

PU to Inverter  
comms. Error  
Inv. Reset ON

#### <Check items>

- 1) Check that the reset signal (across terminals RES-SD) is not ON.
- 2) Check that the parameter unit is fitted in the connector properly.

#### (3) Power-on indication

- 1) When you connect the parameter unit and power on the inverter, the initial screen appears. (For about 3 seconds)

MITSUBISHI

- 2) When communication with the inverter starts, the monitor mode is established.

# CHAPTER 4

# OPERATION

This chapter explains the basic "operation" for use of this product.

Always read the instructions before using the equipment.

4.1 Operation Modes .....	54
4.2 PU Operation .....	56
4.3 Combined Operation (Operation using external input signals and PU) .....	58

Chapter 1

Chapter 2

Chapter 3

Chapter 4

Chapter 5

# 4.1 Operation Modes

## 4.1.1 How to select the operation mode

### (1) Switching from external operation mode [EXT] to PU operation mode [PU]

**Confirmation**

Make sure that the external input signal (STF, STR) is OFF.

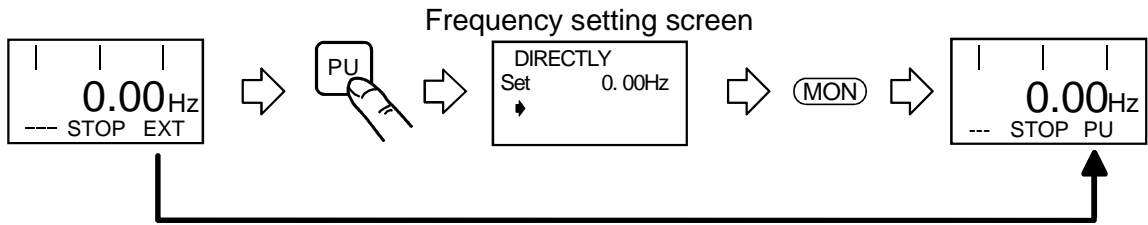

Pressing the **[PU]** key switches to the PU operation mode and changes the operation mode indication to [PU], establishing the PU operation mode.

### (2) Switching from PU operation mode [PU] to external operation mode [EXT]

**Confirmation**

Make sure that the external input signal (STF, STR) is OFF and that the operation command indication is "- - -".

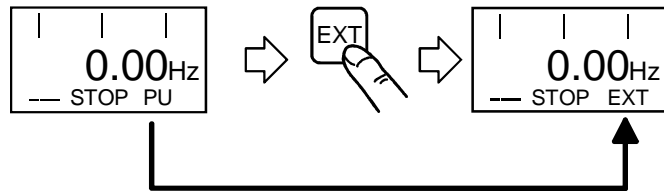

Pressing the **[EXT]** key switches to the external operation mode and changes the operation mode indication to [EXT], establishing the external operation mode.

### (3) Switching to the external / PU combined operation mode

Change the Pr. 79 "operation mode selection" setting as indicated below. "PU+E" is displayed in the operation mode indication position.

**CAUTION**

The functions vary with the inverter.  
(Refer to the inverter instruction manual for details.)

Setting	Description	
	Running frequency setting	Start signal
3	Parameter unit ● Direct setting and   key setting External signal input ● Multi-speed selection (Pr. 4 to Pr. 6, Pr. 24 to Pr. 27)	External signal input ● Terminal STF ● Terminal STR
4	External signal input ● 0 to 5VDC across terminals 2-5 ● 0 to 10VDC across terminals 2-5 ● 4 to 20mADC across terminals 4-5 ● Multi-speed selection (Pr. 4 to Pr. 6, Pr. 24 to Pr. 27) ● JOG frequency (Pr. 15)	Parameter unit ●  key ●  key

**REMARKS**

If the operation mode cannot be switched properly, check the following:

1. External input signal..... Make sure that the signal is off. If it is on,  
(STF or STR signal) the operation mode cannot be switched properly.
2. Parameter setting.....Confirm the Pr. 79 "operation mode selection" setting.  
(Refer to page 54 and the inverter instruction manual.)
3. Limitation of the operation mode..... When Pr. 79 "operation mode selection" setting is other than "0", the operation mode is limited accordingly.



### 4.2.2 PU jog operation

**A500** **F500** **E500** **-NA** **-EC** **-CH** **S500** **-NA** **-EC** **-CH** **F500J** **-CH** **C500**

Hold down the **FWD** or **REV** key to perform operation, and release it to stop.

● Jog operation cannot be performed in the following cases:

- During motor operation
- The jog frequency (Pr. 15) value is less than the starting frequency (Pr. 13) value.

Step	Operation Procedure	Image
1	Switch to the PU operation mode. If the operation mode indication is not [PU], refer to page 54 and switch to the PU operation mode.	<p>1. Power on → Operation mode check</p>
2	The frequency and acceleration/deceleration time for jog operation can be set in the following parameters. <Factory setting> <ul style="list-style-type: none"> <li>• Pr. 15 "jog frequency" ..... 5Hz</li> <li>• Pr. 16 "jog acceleration/deceleration" ..... 0.5s</li> </ul>	<p>2. Running frequency setting</p>
3	Press the <b>PU</b> key, then the <b>SHIFT</b> key. The jog operation mode is selected and the PU JOG frequency setting screen appears on the display. To change the frequency, enter the value and press the <b>WRITE</b> key.	<p>3. Jog operation mode selection</p>
4	Press the <b>FWD</b> or <b>REV</b> key. The display changes to the monitor screen. Hold down the key to perform operation and release it to stop. If the motor does not run, check Pr. 13 "starting frequency". If its setting is less than the starting frequency, the motor will not run.	<p>4. Operation</p>
5	Press the <b>PU</b> key. The inverter exits from the jog operation mode and returns to the ordinary PU operation mode. To return to the jog operation mode, press the <b>SHIFT</b> key.	<p>5. Exit from jog operation mode</p>

#### REMARKS

The jog operation mode may also be selected from the **HELP** key. (Refer to page 33)

**CAUTION**

The functions vary with the inverter. (Refer to the inverter instruction manual for details.)

**4.3.1 Entering the start signal from outside and setting the running frequency from the PU (Pr. 79=3)**

The external frequency setting signals and the PU's **FWD** and **REV** keys are not accepted.

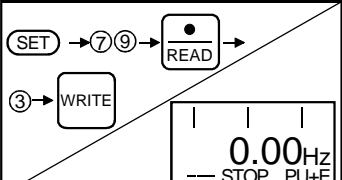
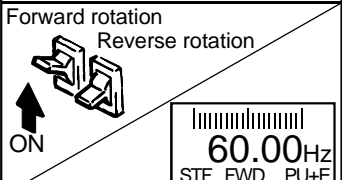
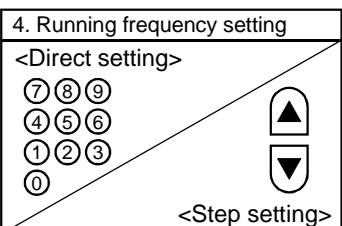
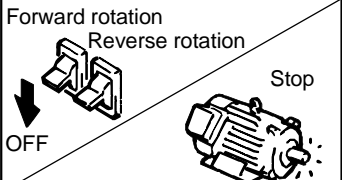

**STOP/RESET** key is valid when Pr. 75 "PU stop selection" = "14 to 17".

Step	Operation Procedure	Image
1	Switch the power on.	<p>1. Power on</p> 
2	Set "3" in Pr. 79 "operation mode selection". The combined operation mode is selected and the operation mode indication on the display changes to "PU+E".	<p>2. Operation mode selection</p> 
3	<p>Set the start switch (STF or STR) to ON.</p> <div style="border: 1px solid black; padding: 5px; margin: 5px 0;"> <p><b>REMARKS</b></p> <p>If the forward and reverse rotation switches are both set to ON, the inverter will not start. Also, if these switches are both set to ON during operation, the motor is decelerated to a stop.</p> </div>	<p>3. Start</p> 
4	<p>Set the running frequency to 60Hz from the parameter unit. The operation command indication changes to "STF" or "STR" and the operation status indication changes to the output (FWD or REV) indication.</p> <ul style="list-style-type: none"> <li>● Direct setting After pressing the <b>PU</b> key, enter the frequency directly with the number keys. Note that this setting is not available in the monitoring mode. In this case, press the <b>PU</b> key to leave the monitoring mode and then re-set the frequency.</li> <li>● Press the <b>PU</b> key to call the frequency setting screen, and perform step setting. Press the <b>▲/▼</b> key to keep on varying the frequency. Hold down the <b>▲</b> (or <b>▼</b>) key to vary the frequency. As the frequency varies slowly at the beginning, this feature may be used for fine adjustment.</li> </ul>	<p>4. Running frequency setting</p> 
5	Set the start switch (STF or STR) to OFF. The motor stops running.	<p>5. Stop</p> 

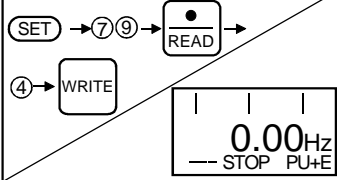
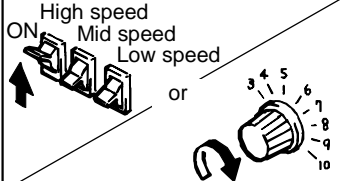
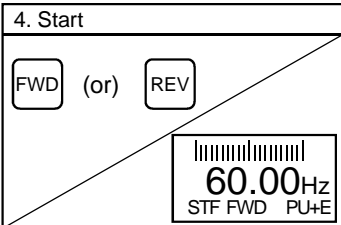
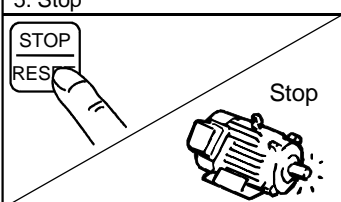
### 4.3.2 Entering the running frequency from outside and making start and stop from the PU (Pr. 79 = 4)

Step	Operation Procedure	Image
1	Switch the power on.	<p>1. Power on</p> 
2	Set "4" in Pr. 79 "operation mode selection". The combined operation mode is selected and the operation mode indication on the display changes to "PU+E".	<p>2. Operation mode selection</p> 
3	Enter the external running frequency signal (select the multi-speed signal or turn the frequency setting potentiometer).	<p>3. Running frequency</p> 
4	<p>Press the <b>FWD</b> or <b>REV</b> key of the PU.</p> <p>The motor starts running.</p> <p>The state of the output frequency is shown on the display.</p> <div style="border: 1px solid black; padding: 5px; margin: 10px 0;"> <p><b>REMARKS</b></p> <p>The starting terminals (STF, STR) of the inverter are invalid.</p> <p>The inverter may also be started by pressing the <b>FWD</b> or <b>REV</b> key of the PU and then increasing the level of the frequency setting signal.</p> </div>	<p>4. Start</p> 
5	<p>Press the <b>STOP/RESET</b> key of the PU.</p> <p>The motor is decelerated to a stop.</p>	<p>5. Stop</p> 

### 4.3.3 Entering the start signal and multi-speed signal from outside and setting multiple speeds from the PU

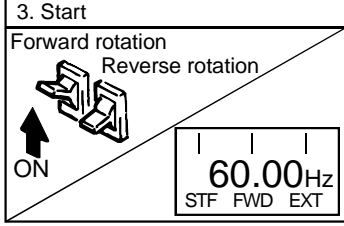
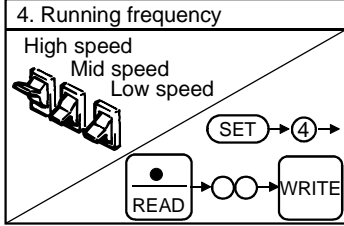
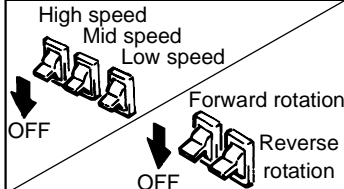
Step	Operation Procedure	Image
1	Switch the power on.	<p>1. Power on</p> 
2	Select the multi-speed signal required for operation (switch the RH, RM, RL or REX signal on).	<p>2. Multi-speed signal selection</p> 
3	<p>Set the start switch (STF or STR signal) to ON. The operation command indication changes to "STF" or "STR", the operation status indication changes to the output (FWD or REV) indication, and the motor starts running.</p> <div style="border: 1px solid black; padding: 5px; margin-top: 10px;"> <p><b>REMARKS</b></p> <p>If the forward and reverse rotation switches are both set to ON, the inverter will not start. Also, if these switches are both set to ON during operation, the motor is decelerated to a stop.</p> </div>	<p>3. Start</p> 
4	<p>Change the multi-speed frequency during running from the PU. When high speed has been selected (RH signal ON), changing the Pr. 4 "three-speed setting (high speed)" value varies the speed.</p> <div style="border: 1px solid black; padding: 5px; margin-top: 10px;"> <p><b>REMARKS</b></p> <p>The other multiple-speed settings not being used may also be changed during operation.</p> </div>	<p>4. Running frequency</p> 
5	<p>Switch off the multi-speed signal (RH, RM, RL or REX signal) and set the start switch (STF or STR signal) to OFF. The motor stops running.</p>	<p>5. Stop</p> 

# CHAPTER 5 SPECIFICATION

This chapter provides the "specifications" for use of this product.

Always read the instructions before using the equipment.

5.1 Specifications .....	61
--------------------------	----

Chapter 1

Chapter 2

Chapter 3

Chapter 4

Chapter 5

# 5.1 Specifications

## 5.1.1 Standard specifications

Item	Specifications
Ambient temperature	-10°C to +50°C (non-freezing) (*1)
Ambient humidity	90%RH or less (non-condensing)
Storage temperature	-20°C to +65°C (*2)
Ambience	Indoors (free from corrosive gas, flammable gas, oil mist, dust and dirt)
Altitude, vibration	Maximum 1000m above sea level for standard operation. 5.9m/s <sup>2</sup> or less (conforming to JIS C 0040)
Power supply	Power is supplied from the inverter.
Connection	Fitted to the inverter or connected to the inverter by the cable.
Display	LCD (liquid crystal display, 13 characters 4 lines)
Size	125 (H) × 70 (W) × 15 (D)
Data retention	Onboard E <sup>2</sup> PROM
Number of write times	Maximum 100,000 times

\*1. At the low temperatures of less than about 0, the liquid crystal display (LCD) may be slower in operation. At high temperatures, the LCD life may become shorter.

\*2. Temperatures applicable for a short time, e.g. in transit.

---

**CAUTION**

---

1. Do not expose the liquid crystal screen to direct sunlight.
  2. During transportation, use care to avoid loading the liquid crystal display.
-



